

Bushton Manufacturing
Maker Of
Hawk Woodworking Tools

MODEL 220 HAWK SCROLL SAW OPERATORS MANUAL

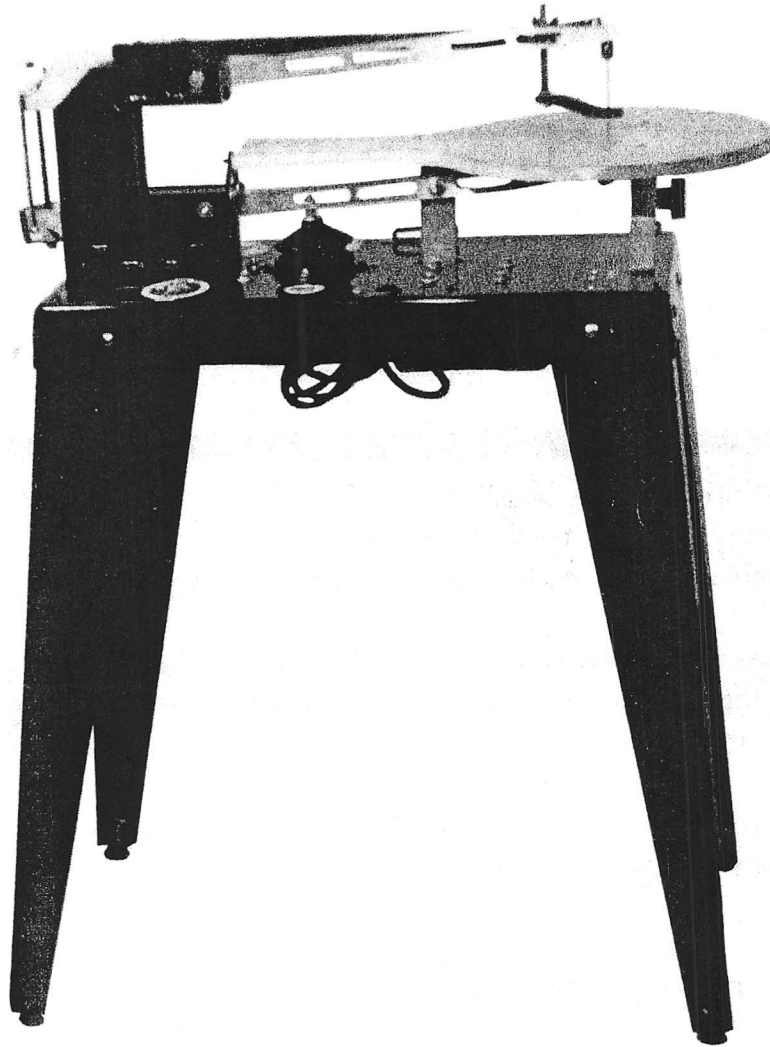

30



**READ THOROUGHLY BEFORE
OPERATING**



MANUAL #HA 0987

CONTENTS

ITEM	PAGE NO.
SAFETY	3
SET-UP INSTRUCTIONS	3
BLADE SELECTION	14
MAINTENANCE	4
SAWING TECHNIQUES	4, 5, 6
TROUBLE SHOOTING	7
BLADE CHANGING	8
ADJUSTMENT AND REPAIR	9, 10, 11
PARTS BREAKDOWN	12, 13
SPECIFICATIONS	15
ACCESSORIES	15
HOW TO ORDER PARTS	15

You Can Reach Us

By Phone 1-620-562-3557
By Fax 1-620-562-3557
By Web jnye@hawkwoodworkingtools.com

TRAINING

1. Read the operators manual carefully. Be thoroughly familiar with the operation of the equipment.
2. Know where the controls are and how to operate them.
3. Wear safety goggles, ear protection and mask in dusty operations.
4. Never allow unsupervised children to operate equipment. Never allow adults to operate the equipment without proper instruction.
5. Keep work area clear of other persons.
6. Maintain a clean uncluttered work area.

OPERATION SAFETY

1. Never make any adjustments while the machine is running.
2. Disconnect electrical power supply before doing any adjustments on the machine.
3. Remove all working tools and equipment before starting machine.
4. Wear proper clothing. Avoid loose fitted clothing, long sleeves, long hair, gloves, neck ties, jewelry, watches, rings, etc.
5. Do not operate an electrical device in a damp or wet area to avoid electrical shock.
6. Maintain all safety guards.
7. Do not operate machine while under the influence of medication, alcohol or drugs.
8. Never leave machine running unattended.
9. Don't overload machine. Follow operators instruction for safe operation.
10. Keep equipment in proper working order. Follow recommended maintenance procedures in the operators manual.

SET UP

NOTE: Damage and/or missing parts are to be reported to the transportation carrier. Manufacturer is not responsible for shipping damage.

This saw is shipped complete in two cartons:

Carton 1

1. Saw
2. Operators manual
3. Extra blades

Carton 2

1. Legs
 2. Glides (leg bottom)
 3. Attaching hardware
1. Remove saw from shipping carton.
 2. Check for damage.
 3. Remove legs from carton.
 4. Install one leg on each corner of the base using 1/4" carriage bolts and nuts. (The top of the leg should be inside of the base.)
 5. Install one 3/8" nut on each of the four glides.
 6. Insert the glides up through the hole in the bottom of the leg. (See Fig. 1)
 7. Install the second 3/8" nut on the glide to secure.
 8. With all of the legs installed, position the saw upright and adjust the nuts on the glides so that each glide supports the saw.

FIG. 1

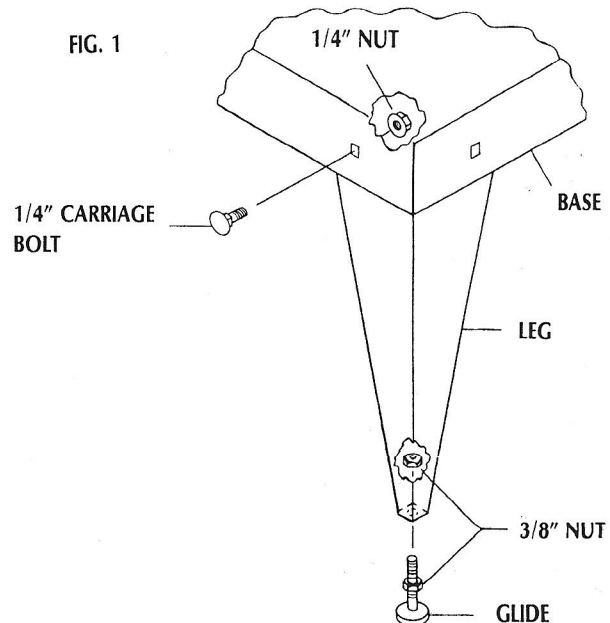

NOTE: Optional adjustable 6" leg extension is available. Part #6LE (See Accessories)

MAINTENANCE

Tensioning Rod:

Add 1 to 2 drops of oil (light machine oil) to the threads of the blade tensioning rod at the bottom arm every 16 hours.

Table:

Keep the table work surface waxed (paraffin wax) to prevent oxidation and allow easier movement of the wood on the table surface.

Cam Over Handle:

Apply wax (paraffin wax) to sliding surface of handle to allow easier use.

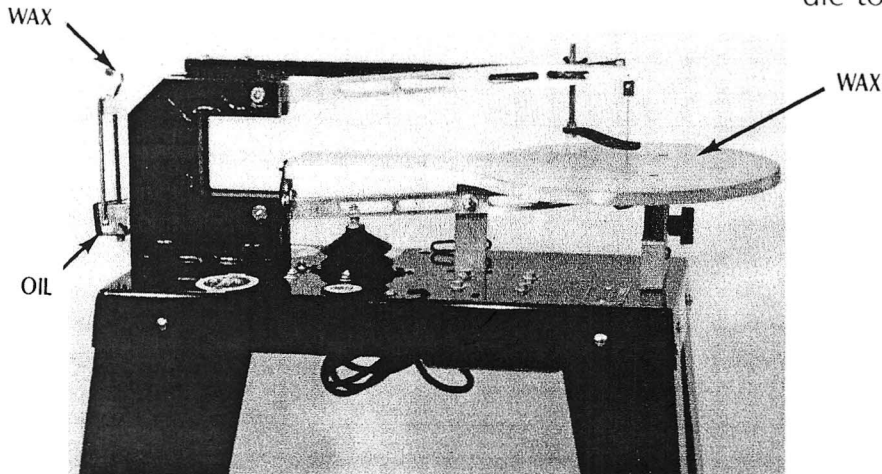

FIG. 2

SAWING TECHNIQUES

Starting:

It is best to begin the cut at a point or corner because it is difficult to smoothly blend in start and end points when starting on a side. When cutting out circular shapes, saw into the pattern line in a crosscutting (across the grain) direction. If the starting point must be on a curve, make it an outside curve. Burrs and knobs are easier to sand on an outside curve.

Sawing:

Feed the piece to be cut slowly into the saw blade while maintaining downward pressure on the piece. Do not force it into the blade—let the saw blade do the work. The speed at which you feed the wood into the blade depends on the type of wood you are cutting. Harder woods should be fed more slowly than softer varieties. Feeding too quickly into the blade may result in the blade burning the wood, bending or twisting of the blade while sawing, a rough edge on the cut, or the wood jumping on the table. Do not apply sideways pressure on the blade. The downward pressure on the wood may be applied by hand or the hold down foot.

Straight-line Cutting:

A small amount of set is formed on one side of most scroll saw blades due to the manufacturing process used to produce them. Because of this, most blades do not cut straight or parallel to the blade. The set causes them to cut a few degrees more to one side than the other. To saw a straight line, the work should be angled approximately 2 to 4 degrees to compensate for this. This may be accomplished freehand or with a guide board. The same technique should be used for straight-line ripping. Be sure that the saw blade is following the layout line and not the grain when ripping. (See Fig. 3)

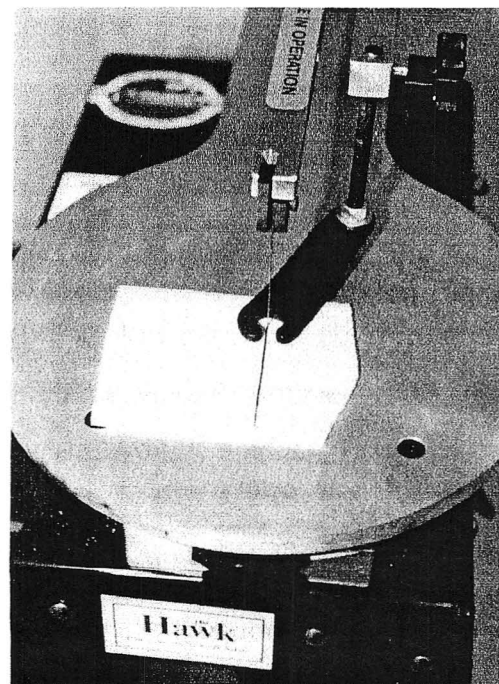

FIG. 3

Turns and Corners:

Scroll saws are capable of producing 360° turns while cutting. The kerf left after a turn is approximately 1/2 the width of the saw blade. When you want to cut a point, simply turn the piece the desired amount while maintaining downward pressure on it. It is not necessary to cut past the point and then restart, like the normal procedure for a band saw. When cutting curves, slowly follow the pattern line, turning the piece as you go so the teeth are following the line. It may be necessary to install a smaller blade when trying to saw an extremely tight corner or radius to prevent the wood from jumping on the table and to prevent blade breakage. (See Fig. 4)

Bevel Sawing:

Bevel sawing is sawing with the table tilted, creating angled sides on the project. This sawing technique may be used to create inlays, decorative letters, or to put shapes into animals or other objects to be carved. To bevel saw on the Hawk, loosen the table tilt assembly knob and tilt the table to the desired angle. (See Fig. 5)

Stack Cutting:

Stack cutting saves time by cutting two or more pieces simultaneously. Simply stack the work pieces on top of each other and draw the pattern on the top piece. The pieces may be held together with double faced tape or nails may be driven into the scrap areas. Cut out the pattern on the top piece and disassemble the stack. Be sure that the saw table is perfectly square with the blade before sawing. (See Table Squaring Procedure) If it is not square, the pieces will not be uniform in size. The stack should not exceed 2" in height. (See Fig. 6)

Sawing Inside Openings:

Sawing inside openings is a common and frequently used process on scroll saws. It is cutting an opening on the inside of the work piece without cutting through the piece. To do this, drill a small hole that is large enough for the blade to pass through near the pattern line of the inside openings. Release blade tension by flipping the cam lock handle to the blade change position. Remove top of blade from the top

blade holder (See Blade Changing). Insert the blade through the drilled hole in the work piece. Install the top of the saw blade back into the top blade holder. Retension the blade by flipping the cam lock handle to its original position. After the cut is finished, remove the blade from the opening. NOTE: Disconnect electrical power supply before making any adjustments to the machine. (See Fig. 7)

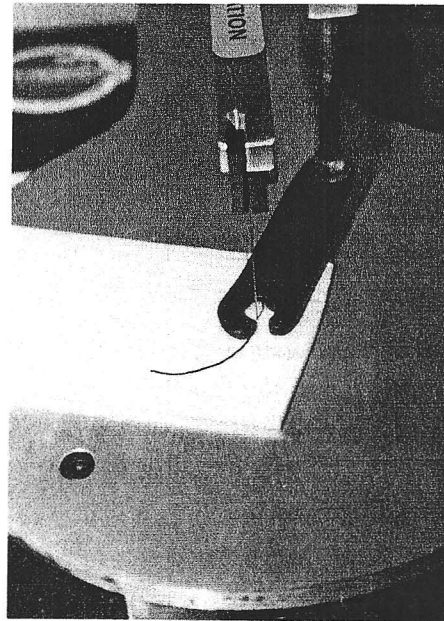

FIG. 5

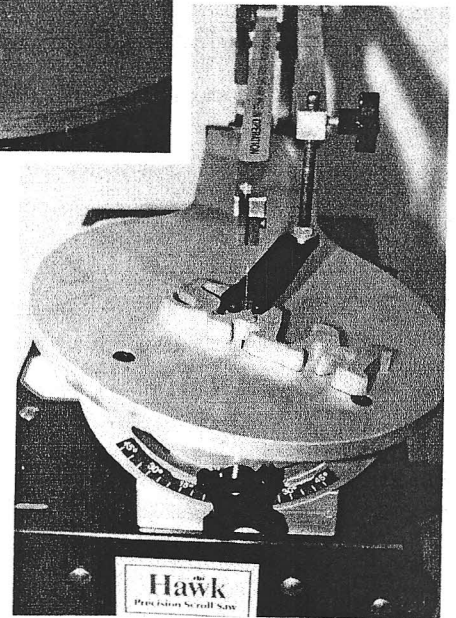
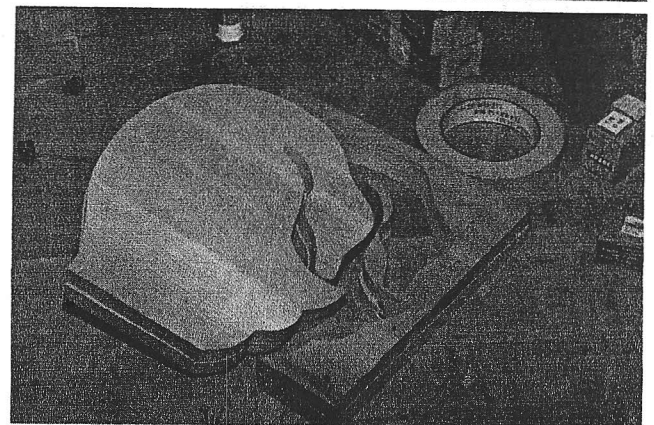

FIG. 6



Compound Sawing:

The compound sawing process involves cutting on two or more sides of the work piece. To do this, simply lay out a pattern on two adjoining surfaces. These patterns may be identical or different. After the patterns are laid out, choose which surface to saw first. It usually will not make any difference which surface you choose, but consider the sequence before choosing. The side that will give the least amount of scrap pieces after it is cut should be first. After the first side is cut, return the scrap pieces to their original locations so that you have a prismatic shape to cutout the second surface. It may be helpful to nail, tape, or glue these scraps back on the piece. (See Fig. 8)

Inlaying:

To create inlaid projects, select two pieces of hardwood that contrast in color (walnut and oak work well). The two must be exactly the same thickness. It is recommended to use 1/4" thick material, but any thickness up to 1 inch will work. Draw the selected design on one of the pieces. Nail the two pieces together with the pattern on the top face. Be sure the nails do not penetrate through the bottom of the project as this will scratch the saw table surface. Drill a very small pilot hole (#60 drill bit) in a corner of the pattern. Slide a #2 blade through the drilled hole and install it in the top blade holder (be sure the pattern is still facing up). Tension the blade and tilt the table approximately 3-1/2° (tilt the table less for thicker material). Tilting to the left will cause the bottom cutout to be the insert. The tilt angle must be increased when using coarser blades. Holding down firmly on your project, begin the cut. Always saw in the same direction from start to finish. Saw around the pattern to the pilot hole and remove the blade. Separate the pieces and press the insert into the outer piece. Tap insert to set firmly. Complete the project by cutting the outside shape and sanding for finish with tung oil, varnish, or clear epoxy.

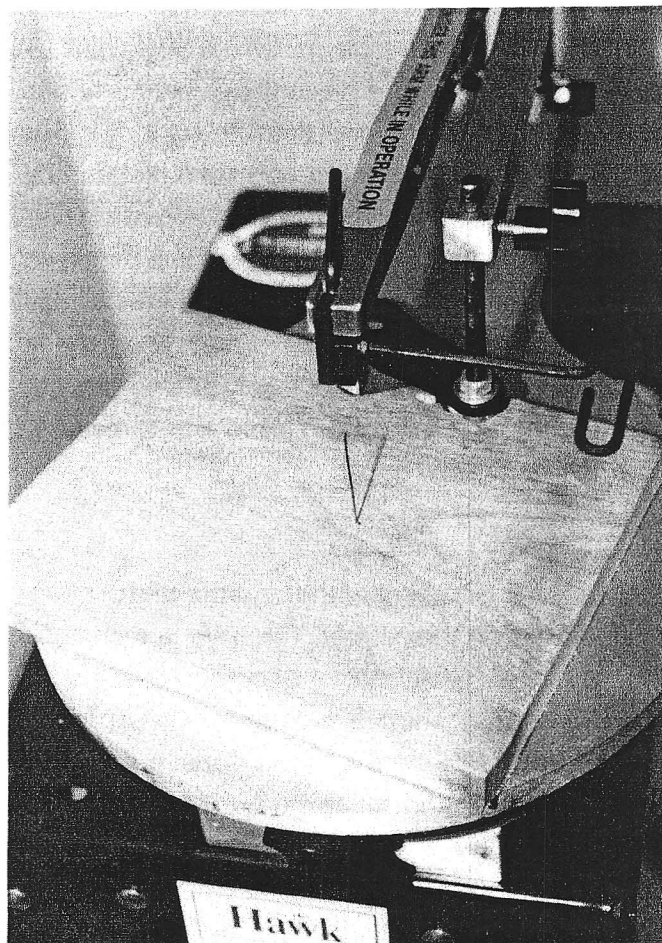
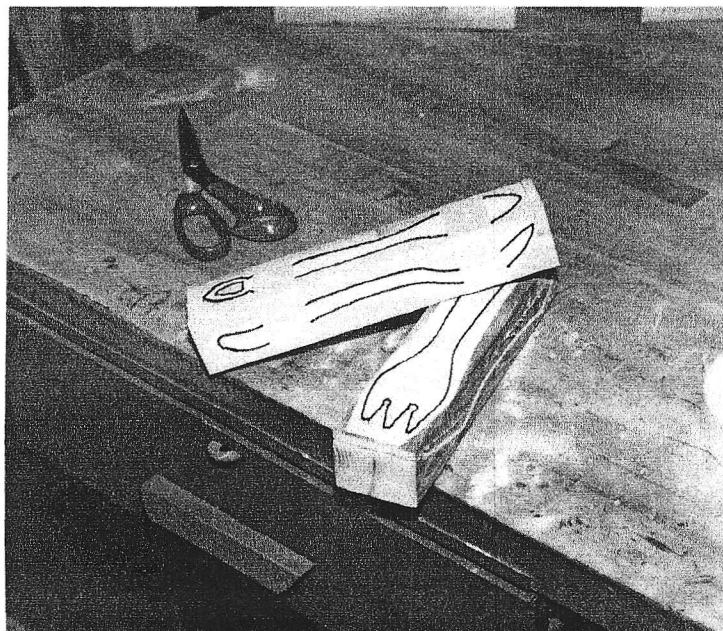

FIG. 7

FIG. 8



TROUBLE SHOOTING GUIDE

PROBLEM	POSSIBLE CAUSE	POSSIBLE SOLUTION			
Excessive blade breakage	Improper blade size for wood thickness	Select proper blade size. Increase blade size for thick wood. See Blade Selection Chart.	Rough cut on the bottom	Blade too large	Use smaller blade. See Blade Selection Chart.
	Cutting too tight a radius for blade size	Increase radius size or reduce blade size. Refer to Turns and Corners in Sawing Section.		Blade tension low	Increase blade tension. See Blade Installation in Saw Procedure.
	Improper blade installation.	Install blade properly. See Blade Installation		Poor quality wood	Use better quality wood.
				Feeding too fast	Slow feed rate. See Sawing section.
Blade burns the wood	Wrong blade size	Increase blade size Refer to Blade Selection Chart.	Blade doesn't follow pattern line	Improper feeding. Feed at an angle right to left of approximately 4° straight into the blade	Practice. See Straight Line Sawing section.
	Cutting too small a radius	Increase radius or decrease blade size. Refer to Turns and Corners in Sawing section.		Operator error—Not following line	Practice.
	Improper feeding	Feed material at 4° right to left. Refer to Straight Line Sawing in Sawing section.		Blade dull	Replace blade. See Blade Changing Procedure.
	Pushing sideways on the blade	Feed straight so not to bend blade left or right. Refer to Sawing section.		Blade too small	Increase blade size See Blade Selection Chart.
	High resin content in wood	Saw against grain when possible, use new blade.		Improper blade tension	Increase tension. See Blade Installation Procedure.
	Feeding too fast	Reduce feed rate. Refer to Sawing section.		Forcing material into the blade.	Reduce feed speed. See Sawing section.
	Improper blade tension	Increase blade tension. Refer to Blade Installation			
Blades bend back excessively or twist while sawing	Improper blade tension	Increase blade tension. Refer to Blade Installation Procedures.	Wood jumps on the table	Improper hold down adjustment	Adjust the hold down to apply pressure to the board.
	Improper blade size	Increase blade size See Blade Selection Chart.		Blade installed upside down	Install blade properly with teeth pointing down. See Blade Changing Procedure.
	Feeding too fast	Slow feed rate. Refer to Sawing section.		Turning too tight of a radius	Increase radius size. See Turns and Corners in Sawing section.
Blade cutting too large a radius	Blade too large	Use smaller blade. See Blade Selection Chart.		Not using hold down and not holding board down firmly	Hold board firmly on the table, especially when turning. Feed properly. See Sawing and Sawing Straight Line sections.
	Blade tension low	Increase blade tension. See Blade Installation Procedures.		Sawing too fast	Reduce feed speed
	Improper feeding	Turn board properly See Turns and Corners in Sawing section.	Bellows not blowing dust away from work area	Pressing sideways on the blade	Feed properly. See Sawing section.
Board splintering on the bottom	Wrong blade size	Use smaller blade. See Blade Selection Chart.		Air leakage around bracket	Turn bracket 90° or flip bracket over
	Wood grain stringy or knotty	Use masking tape on the bottom at the saw line.	Blade stops moving while sawing	Hose kinked	Straighten hose, adjust hose routing
				Belt loose	Tension belt (see procedure)
				Pulley turning on shaft (Loose set screw in pulley)	Tighten set screw. (Be sure screw tightens on flat side of shaft)

PROCEDURE FOR CHANGING THE BLADE

Step 1:

Release the cam-over handle (HA-74) by flipping it over. Now place the "L" shaped quick change hold rod (HA-65) behind the upper blade holder (FA-45) by inserting it with the shortest end in the vertical position and the longer end facing the rear of the saw in the open hole on the top of the upper arm. (Fig. 9) This is to help hold your upper blade holder in a stationary position. Place the 9/64" T handle allen wrench (ES-86) into the allen head cap screw on the right side of the upper blade holder and loosen the allen head cap screw. Remove any pieces left of the old blade. The blade is now ready to be removed from the lower blade holder.

Step 2:

Located in the V notch of the lower arm is a small, barrel shaped blade holder (FA-46) (Fig. 10). Remove it by sliding the blade holder forward and slightly turning towards the front of the saw. This allows the blade to slide forward out of the notch in the arm. When the blade is free from the lower arm notch, slide it to the left or right to remove it from the V notch. Now place the saw blade holder on end in the oblong notch located on the base of your saw. Using a 5/16" open end wrench on the flats of the saw blade holder (FA-46), loosen the saw blade holder and remove the old blade. Insert the new blade (teeth pointing down) between the two halves of the barrel of the blade holder (FA-46). Be sure to touch the bottom of the blade to the top of the center screw of the blade holder.

Step 3:

You are now ready to put the blade and holder into the V notch of the bottom arm. Holding the blade holder (FA-46) in your hand feed the blade through the open slot in the table top making sure the teeth are facing the front of the saw. Slide the blade holder in front of the lower arm until the blade will slide between the open notch in the lower arm. Now slide the blade holder (FA-46) back into the V notch of the lower arm. Pull the blade tightly into the V notch by pulling it through the hole in the table top with the thumb and first finger of your left hand. Place the 9/64" T handle allen wrench (ES-86) into the allen head cap screw in the upper blade holder (FA-45) and pull down the upper arm with pressure applied by your right hand while holding the T handle allen wrench (ES-86). Lower the upper blade holder over the top end of the blade until the top of the blade rests on the center of the allen head cap screw and is touching the roll pin in the middle of the holder. (Fig. 11) Tighten the allen head cap screw securely with the T handle allen wrench (ES-86).

Step 4:

Remove the 9/64" T handle allen wrench and the "L" shaped quick change hold rod from behind the upper blade holder assembly. Tension the blade with the cam-over handle (HA-74) by flipping it back to its original position. To check the blade tension pluck the blade like a guitar string. You should get a crisp ping sound from the blade if it is tensioned correctly. If you don't receive a crisp ping, loosen the cam-over handle (HA-74) by flipping it back to the blade change position and turn it like a knob, making sure the ten-

sion rod (the metal rod that holds the two arms together at the rear) remain stationary while you turn the cam-over. Tighten only 1/2 turn at a time. Retension the cam-over by flipping it back to the original position. Check tension.

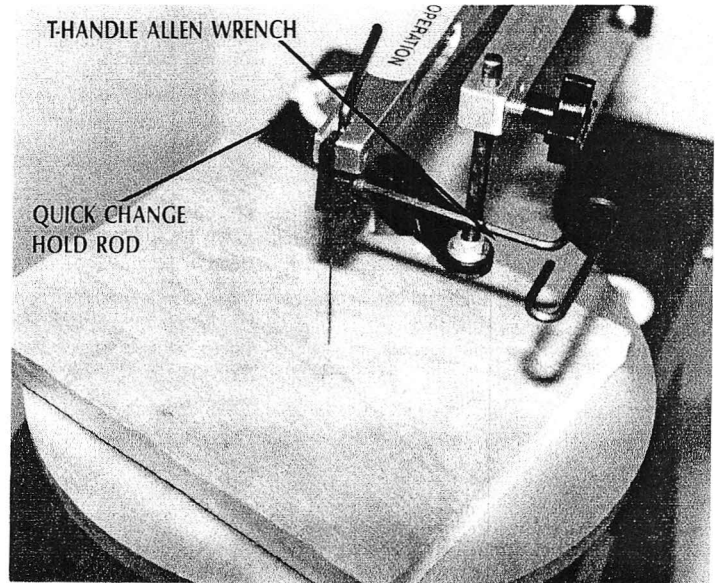

FIG. 9

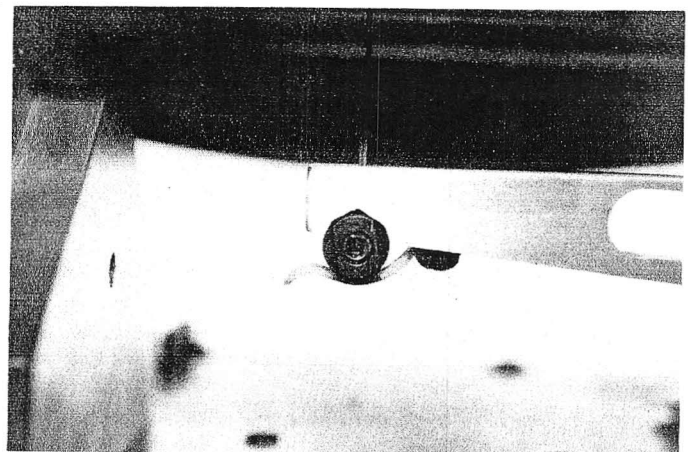

FIG. 10

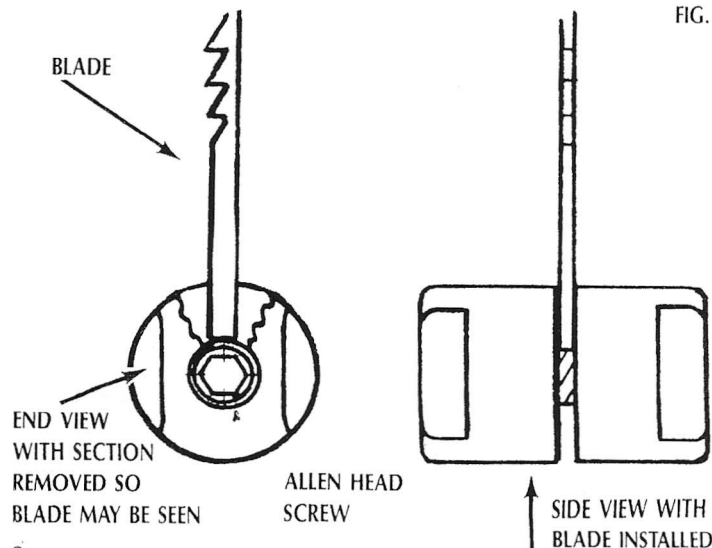

FIG. 11

REMOVAL OF ES-05 TABLE

1. Disconnect electrical power supply.
2. Remove saw blade from saw (see blade changing).
3. Loosen and remove the two 1/4" countersunk socket head screws located at the front of the table. (fig. 12)
4. Loosen and remove the 1/4" bolt connecting the table to the CD-13 rear table support. Remove the table from saw.
5. Reverse procedure for installation.

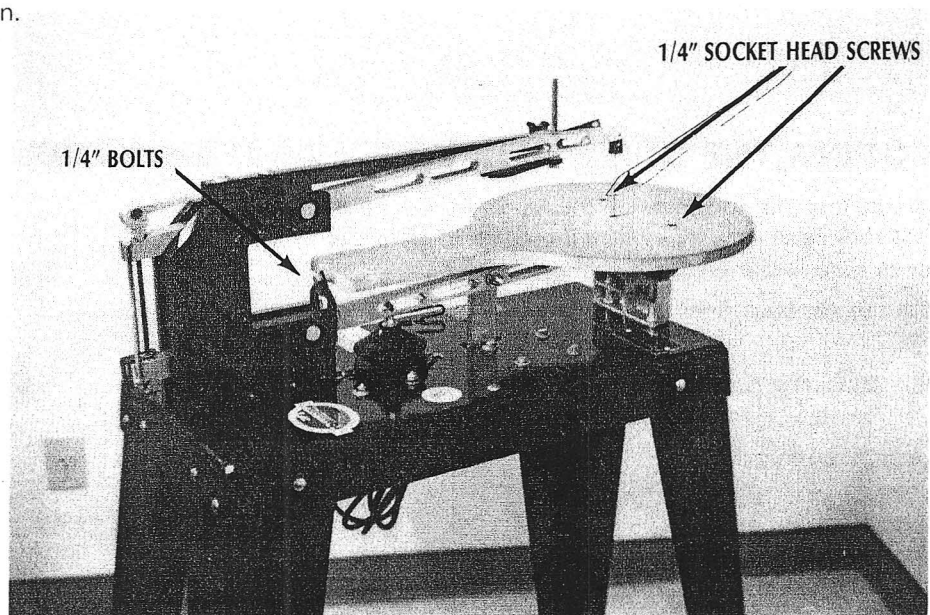

FIG. 12

LEVELING THE TABLE

1. Disconnect from electrical power supply.
2. Place a small 90° square on the table with the back edge of the beam against the blade.
3. Inspect blade and square. The square should fit perfectly against the blade with no openings between them. If there

is an opening, loosen the table tilt knob (ES-42) and adjust the table tilt. (See Fig. 13)

4. When the square fits perfectly against the blade, tighten the table tilt knob. (Fig. 14)

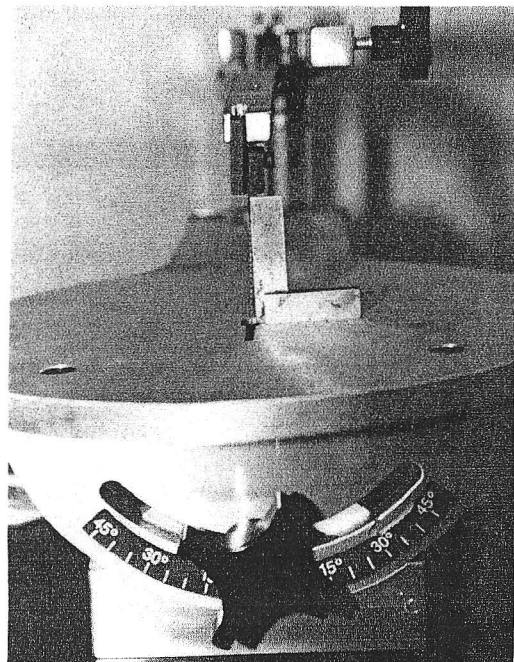

FIG. 13

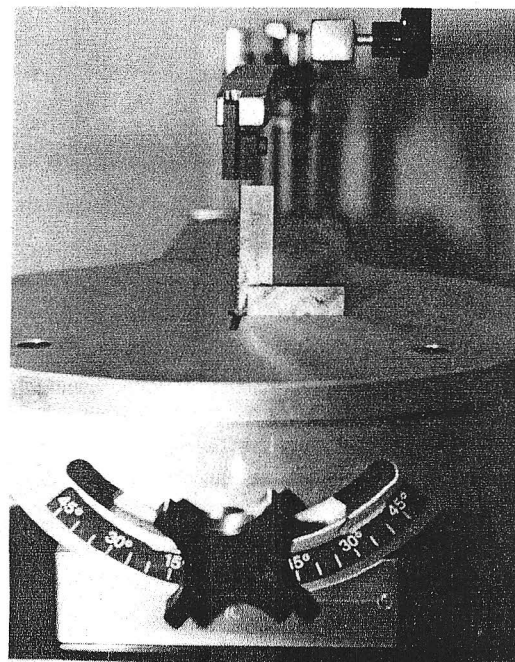

FIG. 14

ADJUSTING HA-104 HOLD DOWN FOOT

1. Release blade tension by flipping cam-over handle up.
2. Loosen knob at the top of hold down arm.
3. Rotate foot counter-clockwise to blade. Slide blade through cutout at end of foot and center in foot.
4. Adjust to desired height.
5. Tighten threaded knob.
6. Tension blade.

TENSIONING THE DRIVE BELT

1. Loosen the four 1/4" lock nuts on the motor mount bolts. (Fig. 15) They need only be loosened enough to allow the motor to slide in the adjustment slots in the base.
2. Slide the motor back until the belt is properly tensioned. (Fig. 16)
3. While maintaining pressure on motor, tighten the motor mount lock nuts.
4. Check belt tension.

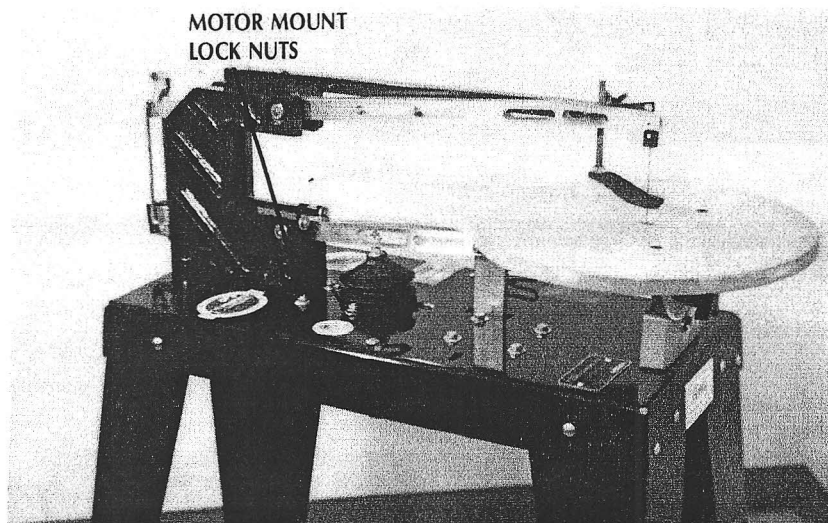

FIG. 15

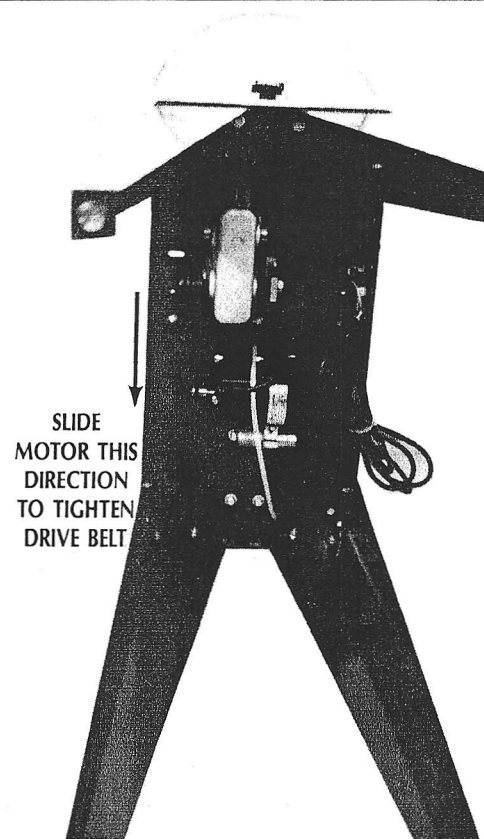

FIG. 16

CHANGING SPEEDS

1. Loosen the four lock nuts on the motor bolts and slide the motor forward. Remove drive belt.
2. Loosen allen head set screw in ES-71 dual V-pulley. Remove pulley and turn around (end for end) so the desired pulley is aligned with the motor pulley. The larger pulley (in diameter) is the slow speed pulley. (fig. 17)
3. Tighten set screw in ES-71 dual V-pulley when pulleys are aligned. Be sure the screws are tightened on the flat side of the shaft.
4. Install the correct belt.
NOTE: The longer belt is the slow speed belt and should be used with the larger diameter pulley. The shorter belt should be used with the smaller pulley.
5. Tension belt (see drive belt tensioning).

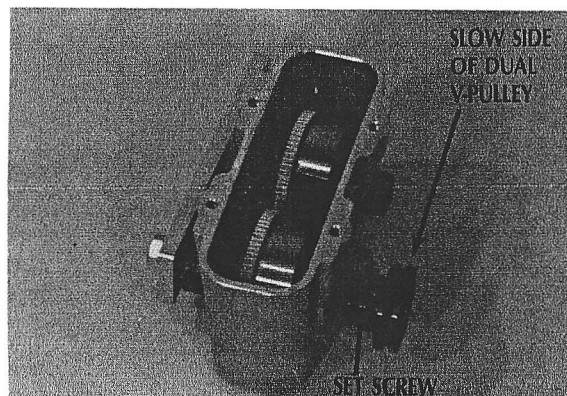

FIG. 17

REMOVAL OF ES-103 GEARBOX HOUSING

1. Disconnect electrical power supply.
2. Loosen the four motor mount carriage bolts and slide motor toward the front of saw.
3. Remove drive belt.
4. Remove shoulder bolt connecting (HA-53) lower arm and (HA-69) pitman arm. (fig. 18)
5. Loosen and remove the four 1/4" bolts holding the gearbox housing to the base while applying upward pressure on housing.
6. Lower gearbox housing with pitman arm still connected from underneath base.
7. Reverse procedure to install.

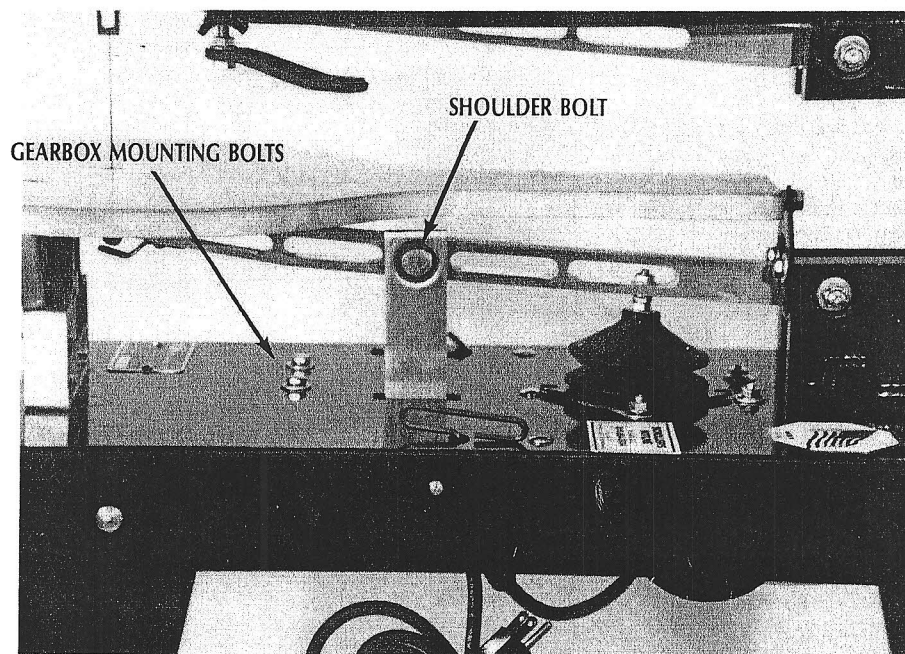

FIG. 18

TIMING THE ES-91 COUNTER WEIGHTS IN GEARBOX

1. Rotate the pitman shaft to where threaded stud is on bottom and flats on shaft are facing up.
2. Slide counter weight and attached gear on shaft against the right side (pitman arm side) bearing. Rotate weight and gear on shaft until set screw is straight up (vertical). (fig. 19)
3. Apply loctite or similar thread locking agent to set screw. Tighten set screw. Be sure counter weight is against bearing.
4. Rotate the other counter weight on counter shaft to the same position (set screw facing up). Slide to the right until it is against bearing. It may be necessary to rotate this gear and weight slightly so it will mesh with the other gear.
5. When gears are aligned, apply loctite or similar thread locking agent to set screw and tighten. (fig. 20)
6. Check the weights by rotating pitman shaft until the threaded stud is facing up. The points of both weights should be facing up.

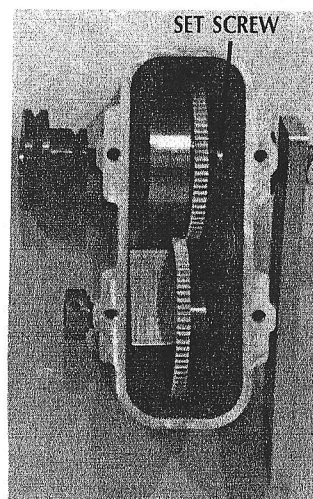

FIG. 19

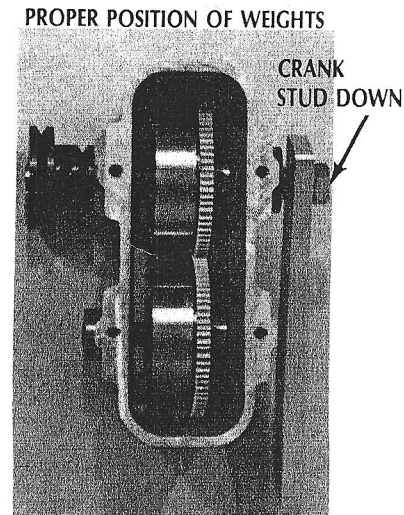
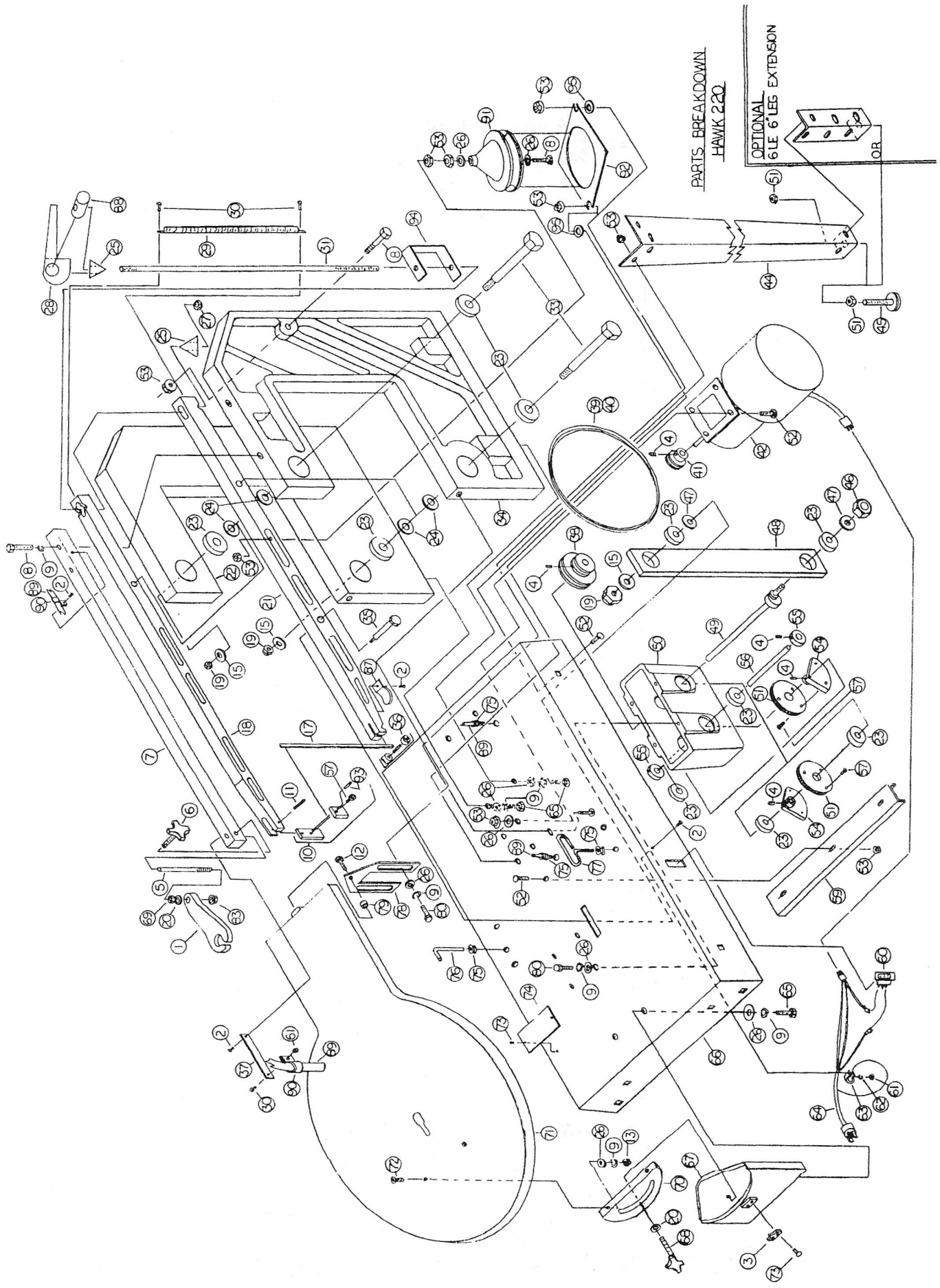

FIG. 20

PARTS BREAKDOWN HAWK 220

	PART#	QUANT.			
1. Pressor Foot	HA-104	1	48. Pitman Arm	HA-69	1
2. 10-32 x 1/2" Machine Screw	RB-106	3	49. Pitman Shaft	ES-12-V	1
3. Plastic Pointer	HA-101	1	50. Gearbox Housing	ES-103	1
4. 1/4-20 x 1/4" Set Screw	RZ-83	6	51. Gear	ES-92	2
5. Shaft (Foot to Arm)	SH-12	1	52. 1/4-20 x 5/8" Carriage Bolt	RB-99	20
6. Threaded Knob	ES-40	1	53. 1/4" Lock Nut	RB-223	21
7. Holddown Arm	HA-66-X	1	54. Counter Weight	ES-91-Y	2
8. 1/4-20 x 1 1/4" Hex Head Bolt	PS-80	3	55. Collar	ES-15	2
9. 1/4" Lock Washer	RBZ-207	16	56. Shaft	ES-97	1
10. Top Blade Holder Assembly	FA-45	1	57. 8-32 x 1/2" Socket Head Cap Screw	ES-90	7
11. Roll Pin 1/8" x 3/4"	FA-42	1	59. Base Brace	HA-12	1
12. 5/16" x 1 1/4" Hex Head Bolt	RZ-181	1	60. Switch	HA-61	1
13. 1/4-28 Hex Nut	ES-49	2	61. 10-32 Hex Nut	RB-107	1
15. 3/8" Flat Washer	RZ-50	3	62. 10-32 Split Lock Washer	RB-519	1
17. Saw Blades (Order by # or Pitch)			63. Cable Clamp	HA-76	1
18. Top Arm	HA-52	1	64. Electric Cord Set	HA-60	1
19. 3/8"16 Nylon Lock Nut	RZ-51	3	65. 1/4-20 x 1" Hex Hd. Bolt	PS-52	6
20. 5/16" Flat Washer	RB-150	1	66. Base (2-Speed)	HA-64	1
21. Lower Arm	HA-53-Z	1	67. Base Tilt	HA-27-P	1
22. R. H. Arm Support	HA-50	1	68. Table Tilt Knob 5/16-18 x 1"	ES-42	1
23. Bearing	PS-07	10	69. 5/16-18 Hex Nut	RZ-81	1
24. Spacer	HA-67	4	70. Table Tilt	HA-20-P	1
25. Connector Rod Pivot	HA-18	2	71. Table	ES-05-Y	1
26. 1/4" Flat Washer	RB-177	18	72. 1/4" Socket Flat Head 1/4-28 x 3/4"	RZ-182	2
27. 1/4"20 Neopreme Lock Nut	HA-78	1	73. #7 Drive Screw	FA-12	4
28. Handle	HA-74	1	74. Serial Tab	HA-70	1
29. Spring	FA-36	1	75. Rubber Grommet	HA-16	2
30. 10-32 x 1/4" Rd. Hd. Slotted Screw	FA-35	3	76. Quick Change Hold Rod	HA-65	1
31. Blade Tension Rod	SH-01	1	77. 9/64" T Allen Wrench	ES-86	1
33. Shoulder Bolt 1 3/4"	HA-71	2	78. Rear Table Support	CD-13	1
34. L.H. Arm Support	HA-51	1	79. Nylon Slide Spacer	RB-517	1
35. Shoulder Bolt 1 1/16"	HA-13	1	80. 1/4-20 x 3/4" Hex Hd. Bolt	RBZ-206	6
36. Saw Blade Holder	FA-46	1	87. Plastic Blade Holder Clip	HA-99	1
37. Hose Clip Bracket	ES-82	1	88. Round Handle Pivot	HA-77	1
38. V-Pulley (Dual Polyflex)	HA-56	1	89. Tubing	HA-37	1
39. Polyflex Belt (Fast) 5M425	ES-72	1	90. Clamp	ES-81	2
40. Polyflex Belt (Slow) 5M450	ES-73	1	91. Rubber Bellows	HA-24	1
41. Motor Sheave (Polyflex)	ES-70	1	92. Bellows Holddown Bracket	HA-25	1
42. Motor	HA-55	1	93. 1/8 x 1/2" Roll Pin	FA-43	1
44. Leg	CD-07	4	94. Wedge Hold Bracket	HA-97	1
45. Glides (4) with 8 Nuts	ES-57	4	95. Plastic Spacer .062"	HA-103	2
46. 1/2" Jam Nut	HA-68	1			
47. Spacer	HA-14	2			



SPECIFICATIONS HAWK 220

Length:	33"
Width:	16"
Height:	45 1/2" (with legs)
Weight:	98 lbs.
Throat Depth:	20"
Max. Cutting Depth:	2"
Stroke:	1 1/8"
Strokes Per Minute:	700-1300
Motor:	1/8 H.P. TEFC
Drive:	Belt

ACCESSORIES

LIGHT

2LK STANDARD LIGHT

Heavy duty flexible arm, 16" long which uses a maximum 60 watt incandescent bulb with metal globe. Allows light to be put close to the work and maintain this position. Comes complete with everything to mount to your saw.

2MK MAGNIFIER LIGHT

Flexible arm light with built-in 2 to 1 magnification lens and scale to measure through the lens. Comes with bracket to attach to a work bench edge. Uses 60 watt incandescent bulb maximum.

6LE LEG EXTENSION KIT

Bottom mounted leg extension which increases the height of your saw up to six inches, with 2" increment adjustments.

HA-84 FOOT SWITCH

Switch enables user to turn saw on and off by foot, leaving the hands free. Plugs directly into switch cord and requires no wiring.

HA-85 BLADE ALIGNMENT FIXTURE

Fixture that holds bottom blade holder and aligns the blade to the center screw. Ensures proper blade installation into the bottom holder.

HA-87 BLADE HOLDER RACK

Rack mounts to base and holds up to six bottom blade holders with blades installed. Saves time when changing blades.

For Factory Direct Pricing Call:
HAWK Woodworking Tools
Customer Service
1-620-562-3557