

Bushton Manufacturing
107 South Main P.O. Box 127
Bushton, KS 67427
Phone: 620-562-3557 Fax: 620-562-3557

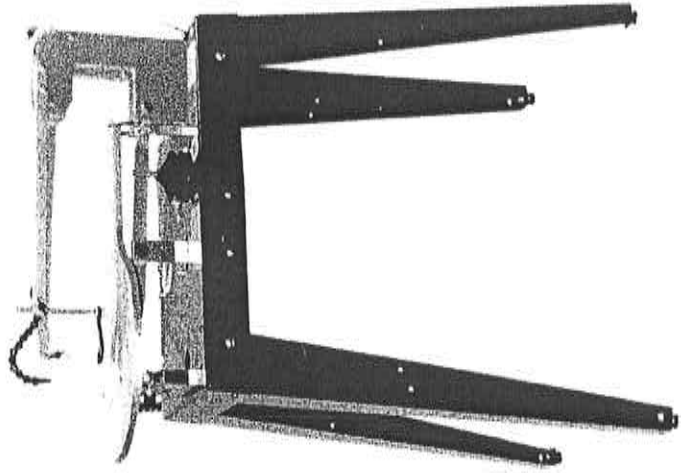

MODELS 216, 220 & 226 HAWK ULTRAS



**READ THOROUGHLY BEFORE
OPERATING**

“America’s Woodworking Machinery Manufacturer”



MANUAL #: 703-5729

CODE #: 0400-1500

TABLE OF CONTENTS (RBI HAWK ULTRA PRECISION SCROLL SAWS)

Set Up.....	3
Maintenance.....	4
Grounding Instructions.....	5
Safety Tips.....	S-7
Let's Try It Out.....	7
Sawing Techniques.....	8
Practice Techniques.....	8
Making A Project.....	9
Blades For Every Occasion.....	9
Blade Chart.....	10-11
How To Change A Blade.....	12-13
Blade Tensioning.....	14
Advanced Scroll Sawing.....	15
Bevel Sawing.....	15
Stack Cutting.....	16
Compound Sawing.....	17
Troubleshooting.....	18-19
Ordering Replacement Parts.....	19
Parts Breakdown 216 Hawk Ultra.....	20
Parts List 216 Hawk Ultra.....	21
Parts Breakdown 220 Hawk Ultra.....	22
Parts List 220 Hawk Ultra.....	23
Parts Breakdown 226 Hawk Ultra.....	24
Parts List 226 Hawk Ultra.....	25
Table Tilt Adjustment Procedures.....	26
Grounding Drawings & Chart.....	30
Accessories For Hawk Ultras 216, 220, & 226.....	31

SETTING UP YOUR HAWK

Your new **Hawk Ultra** has been completely assembled and factory tested before being prepared for shipment. All adjustments have been made except for a few minor assembly procedures. After these procedures are completed, you'll be on your way to scrolling in no time!

The **Hawk Ultra** is shipped in three separate cartons:

Carton #1 contains "**YOUR NEW SAW**" and your personal scroll saw manual.

Carton #2 contains four commercial duty 36 inch steel legs, leg assembly hardware, and glides (rubber feet).

Carton #3 contains the Beginner's Choice Kit (pattern pack, blade assortment pack, scroll saw video, and pattern book). We often ship additional items in each carton, if ordered. Be sure to compare the items received with the packing list attached to each shipment. There will be one packing list for an entire shipment. If your shipment contains more than one carton, the packing list will be attached to the largest carton. Also listed on the packing list, you will notice an individual six digit customer identification number has been assigned to you. Please record this number for further contact with RBindustries, Inc.. It identifies you with each piece of RBI equipment purchased.

While removing all items from their cartons, be sure to inspect each one closely for shipping damage. If you feel your shipment may have been damaged, contact the local office of the transportation carrier. You will find their local number in the yellow pages under "Shipping Carriers". Also, please contact our customer service department for help in resolving any problem.

Tools you will need to complete the final assembly of your **Hawk Ultra**:

(Estimated total time needed: 15 minutes - maximum)

7/16" wrench or ratchet

9/16" open end wrench

A pair of standard pliers

Step #1

Remove the assembly hardware from the plastic pouch and install one 3/8" hex nut on each glide (rubber foot). Tighten each all the way down until they are touching the rubber on the glide stem. (See Fig. A-1)

Step #2

Insert each glide through the hole in the bottom of each leg. Install another 3/8" hex nut on the glide to hold it in place. Tighten the nut down securely. By tightening the nut down securely, your machine's vibration will be minimized. (see fig. A-1).

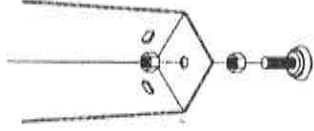

Fig. A-1

Step #3

After removing all items from the saw box, close it and use it as a bench when installing

the legs on your saw. Save your box in case a warranty situation arises. Turn the saw on its side and carefully lay it on the box, **switch(controller) side up**. Install one leg on each corner of the base, using the carriage bolts and the 1/4" whiz nuts. Do not tighten completely. The carriage bolts should be able to move freely in the holes. Tighten these with a wrench when making final adjustments. Be sure the wide top of the leg is **inside** the base. Arrange bolt heads on the outside of the base with the whiz nuts to the inside of the base (see fig. A-2).

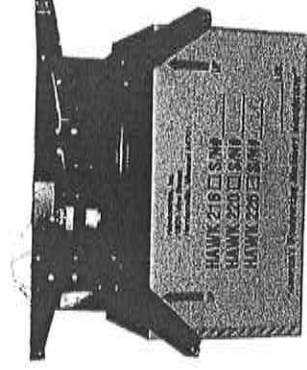

Fig. A-2

Step #4

With the legs installed, stand your new **Hawk** upright and securely tighten the carriage bolts on the legs with a 7/16" wrench or ratchet. For best operation of your saw, be sure to set it on a solid, level floor.

Step #5

Remove the rubber band from the rear aluminum cam-over handle on the rear of the upper arm. It should be adjusted and pointed in the forward position. This will put tension on the blade. On the left hand side of the front section of the upper arm (Unit #220 & 226 only), there is a small black tension adjustment handle. Push the handle backwards and one should feel tension begin to tighten. See figures A-5 and A-6 on page #13 for configuration of black front tension-cam handle.

Step #6

The final adjustment that you will want to make is to direct the dust blower flexible hose. The adjustable dust blower hose is connected to the hold down arm. Adjust the blower nozzle directly at the hole in the center of the saw table. When adjusting your dust blower, it should keep an area the size of a half dollar directly around the blade clear of dust. Always adjust the blower nozzle to direct the dust away from the operator.

MAINTENANCE

There are a few more things you'll want to do before you begin to saw. Don't forget these handy tips. Later, they should be done about every 20 hours of use.

Tip #1-Using light machine oil (3-In-1 Brand Oil is good), put a few drops under the wedge pivot at the rear tension aluminum cam handle. You should also put a drop of oil on each side of the pivot point bearings (This is where the bolts that pivot the arms are located. The bearings are located between the the arms and the arm supports.)

Tip #2-Apply one drop of oil in the hole located on top of the upper arm (area directly above the black rubber front cam handle) **every 20 hours of operation** (Unit #220 & 226 Only).

Tip #3-Although we hand polish each **Hawk** table at the factory, after about 20 hours of use you may want to reapply a coat of wax to the table for protection as well as making the wood glide easier across the table surface. Apply Minwax Clear Wood Wax or Johnson Paste Wax with light pressure in a circular motion. Polish with a clean dry cloth. Be sure to remove all wax from the table top or it will coat your wood as you cut and make applying finishing stains or sealers difficult and their coatings uneven.

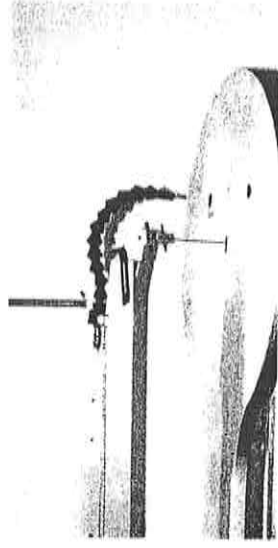

Fig. A-3

GROUNDING INSTRUCTIONS FOR YOUR HAWK

1. All grounded, cord-connected tools:

In the event of a malfunction or breakdown, grounding provides a path of least resistance for electric current to reduce the risk of electric shock. Every **Hawk Ultra** is equipped with an electric cord having an equipment-grounding conductor and a grounding plug. The plug must be plugged into a matching outlet which is properly installed and grounded in accordance with all local applicable codes and ordinances. (See page # 30)

Do not modify the plug provided --- if it will not fit the outlet, have the proper outlet installed by a qualified electrician.

Improper connection of the equipment-grounding conductor can result in a risk of electric shock. The conductor with insulation having an outer surface that is green, with or without yellow stripes, is the equipment-grounding conductor. If repair or replacement of the electric cord or plug is necessary, do not connect the equipment-grounding conductor to a live terminal.

Check with a qualified electrician or service personnel if the grounding instructions are not completely understood, or if in doubt as to whether the tool is properly grounded.

Use only 3-wire extension cords that have 3-prong grounding plugs and a 3-pole receptacle that accepts the tool's plug.

Repair or replace a damaged or worn cord immediately.

2. Grounded, cord-connected tools intended for use on a supply circuit having nominal rating less than 150 volts:

This tool is intended for use on a circuit that has an outlet that looks like the one illustrated in Sketch A Figure 72.1 on page #30. The tool has a grounding plug that looks like the plug illustrated in Sketch A Figure 72.1 on page #30. A temporary adapter, which looks like the adapter illustrated in Sketches B and C, may be used to connect this plug to a 2-pole receptacle as shown in Sketch B if properly grounded outlet is not available. The temporary adapter should be used only until a properly grounded outlet can be installed by a qualified electrician. The green-colored rigid ear, lug, and the like, extending from the adapter must be connected to a permanent ground such as a properly grounded outlet box.

LET'S GO OVER A FEW SAFETY TIPS

Tip #1-Due to using a DC brush type motor, your **Ultra Hawk** saw should not be plugged into a GFI (Ground Fault Interrupt) receptical.

Tip #2-Never allow anyone without proper training to use your **Hawk**. Children should always be carefully supervised while sawing.

Tip #3-A clean workshop is a safe workshop. Keep your work area clean and uncluttered. Also, keep others clear of running machinery. Be sure to remove all tools and wood scraps before starting the machine.

Tip #4-Keep your hands/fingers away from all moving parts. Never try to make any adjustments to your **Hawk** while it's running. The electrical power should be disconnected before making any adjustments on the machine.

Tip #5-Dress for the occasion. Loose clothing and jewelry can be a hazard around working tools. Avoid loose fitting clothes, long sleeves, neckties, jewelry, rings, watches, etc. If you have long hair, be sure to pull it back. Always wear eye protection, ear protection, and a mask in dusty operations.

Tip #6-To avoid electrical shock, do not operate your **Hawk** in a damp or wet area. Always keep safety guards in place. Never leave your saw running unattended.

Tip #7-Be sure to use good materials for a top notch job. When cutting wood, be sure it has no loose knots or splintered surfaces.

Safety With all Tools as Applicable :

1. **KEEP ALL GUARDS IN PLACE** and in working order.
2. **REMOVE ADJUSTING KEYS AND WRENCHES.** Form a habit of checking to see that keys, tools, and adjusting wrenches are removed from the machine before turning it on.
3. **KEEP WORK AREAS CLEAN.** Cluttered areas and benches invite accidents.
4. **DON'T USE IN DANGEROUS ENVIRONMENTS.** Don't use power tools in damp or wet locations, or expose them to rain. Keep work areas well lighted.
5. **KEEP CHILDREN AWAY.** All visitors should be kept at a safe distance from work areas. Visitors should also wear eye, ear, and dust protection.
6. **MAKE YOUR WORKSHOP KID PROOF** with padlocks, master switches, and by removing starter keys. Every Hawk comes equipped with a red locking safety switch key. Remove the red key when the saw is not in use. (see pg.14)
7. **DON'T FORCE TOOL.** It will do the job better and safer at the rate for which it was designed.
8. **USE CORRECT TOOL.** Don't force a tool or attachment to do a job for which it was not designed.
9. **USE PROPER EXTENSION CORD.** Make sure your extension cord is in good condition. When using an extension cord, be sure to use one heavy enough to carry the current load your product will draw. An undersized cord will cause a drop in line voltage resulting in loss of power and over-heating. Table 72.1 (see page 30) shows the correct size to use depending on cord length and name plate ampere rating. If in doubt, use the next heavier gage. The smaller the gage number, the heavier the cord.
10. **WEAR PROPER APPAREL.** Do not wear loose clothing, gloves, neckties, rings, bracelets, or any other jewelry which may get caught in moving parts. Non-slip footwear is recommended. Wear protective hair covering to contain long hair. Use dust masks if the cutting operation is dusty!
11. **ALWAYS USE "SAFETY GLASSES".** Everyday glasses have very minimal impact resistant lenses. They are **NOT** safety glasses.
12. **SECURE WORK.** Use clamps, vises, or hold downs while working. It's safer than using your hand, and it frees **both** hands to operate tool.
13. **DON'T OVER-REACH.** Keep proper footing and balance at all times.
14. **MAINTAIN TOOLS WITH CARE.** Keep sharp and clean for best and safest performance. Follow instructions for lubricating and changing instructions.
15. **DISCONNECT TOOLS FROM ELECTRICAL POWER SOURCE** before servicing; when changing accessories, such as blades, bits, cutters, etc.

16. **REDUCE THE RISK OF UNINTENTIONAL STARTING.** Make sure the switch is in the "off" position before plugging into the electrical outlet.
17. **USE RECOMMENDED ACCESSORIES.** Consult the owner's manual for recommended accessories. The use of improper accessories may cause risk of injury to the operator.
18. **NEVER STAND ON TOOL.** Serious injury can occur if the tool is tipped or if the cutting blade is unintentionally contacted.
19. **CHECK DAMAGED PARTS.** Before further use of the tool, a guard or other part that is damaged should be carefully checked to determine that it will still operate properly and perform its intended function --- check for alignment of moving parts, binding of moving parts, breakage of parts, mountings, and any other conditions that could affect its operation. Again, a guard or other part that is damaged should be properly repaired or replaced.
20. **DIRECTION OF FEED.** Feed work into the blade or cutter, against the direction of rotation of the blade or cutter only.
21. **NEVER LEAVE ANY TOOL RUNNING UNATTENDED. TURN THE POWER OFF.** Don't leave the tool until it comes to a complete stop.
22. **DO NOT OPERATE MACHINE** under influence of medication, alcohol, or drugs or in a state of severe fatigue.
23. **KEEP EQUIPMENT IN PROPER WORKING ORDER.** Follow recommended maintenance procedures in the operators manual. It is the owners' responsibility to maintain equipment to RBI manual specifications.

LET'S TRY IT OUT

After we test each **Hawk** saw, we leave the "test run" blade installed. This blade is a size #7 fret saw blade. (There are many different sizes and types of blades available, see pages 10-11 for a partial listing). This #7 blade will work very well for the beginning exercises. The most important thing to remember is to relax. Don't be afraid of the saw --- It is a very safe tool --- but it must be respected!

For this project you will need:

1 = 1" x 9" x 11" piece of clear soft wood (pine will work great).

Before you begin, you will need to get the pattern of the jumping dolphin puzzle located in the RBI Pattern Pak enclosed with your saw. There are several ways to transfer patterns to your project material. Here are a couple of inexpensive ways we have found to be of help:

1. **Carbon Method --** Using a sheet of carbon paper (available at the local stationary shop), place it directly on the surface you plan to cut. Lay the original pattern or a photocopy directly on top of the carbon paper and carefully trace the pattern using a pencil or ball-point pen (if you use a sharp pencil you might tear the carbon paper, so a dull pencil may be better for you). Lift the pattern and carbon paper from the surface and you're ready to cut. **Warning: Depending on the material you plan to cut, the carbon from the paper may be very difficult to remove from the surface. Be sure to carefully sand away all carbon or it will tend to bleed when applying stain or finish sealer later.**
2. **Stick it --** This is our most used method. Make a photocopy pattern, carefully spray aerosol adhesive directly to the back side of the pattern. Never spray the wood itself. Always spray the paper pattern! Place the pattern face-side-up on the surface to be cut and rub gently to make sure all edges will be secure while cutting. **Note: When choosing a spray glue, use repositional glue. The type intended for photographs is best.** After your cutting is completed, remove the pattern from the surface and lightly sand to remove any glue residue before finishing. (Some crafters tell us that they use the same technique with rubber cement or a craft glue stick instead of spray adhesive.)

For your first project, it is better to choose a soft wood to cut. We recommend sugar pine or ponderosa pine if it is available. Use the pattern of the jumping dolphin puzzle and prepare your project to be cut by attaching the pattern by the method of your personal preference.

Now it's time to adjust the "hold down foot" on your **Hawk** to fit the thickness of the wood you will be cutting. The "hold down foot" is the black nylon (plastic) piece that surrounds the blade on your saw (see item #70 on the parts listing for your particular saw). Using the black plastic knob on the right hand side of the hold-down arm, located next to the upper arm, loosen the knob and raise the "hold down foot". Now place the project you plan to cut on the table and bring the "hold down foot" back down until it gently rests on the top surface of your project (minimal pressure is needed to hold the project in place). Re-tighten the knob, thereby lightly securing the project under the hold-down foot.

SAWING TECHNIQUES THE PROFESSIONALS USE

It is best to start your cut at a "point" or "corner" of the project. Even for an experienced cutter, it is almost impossible to blend starting and ending cuts on a straight line. If your pattern doesn't have a corner, start sawing into the pattern line cutting across the grain. Your chances of the blade not "wandering" will be minimized.

If it becomes necessary to start a cut on a long curve, try to cut just a little outside the line --- you can sand off the resulting bump.

HERE'S A PRACTICE EXERCISE FOR TECHNIQUE

Over the years, we've learned several ways to help beginners enjoy working with their new **Hawk** right away. Here's a technique-building tip that has helped many get started, while getting used to the cutting action of their saw.

Step #1 --- Take a piece of paper (or draw directly on the wood with a felt tip or ball-point pen) and draw a series of straight and zigzag lines like the ones in the diagram. (See fig. A-4.)

Step #2 --- After your wood is covered with lines, start cutting using the techniques above. After you've completed this project and you're comfortable with making sharp turns and straight lines, you're ready to start your first project.

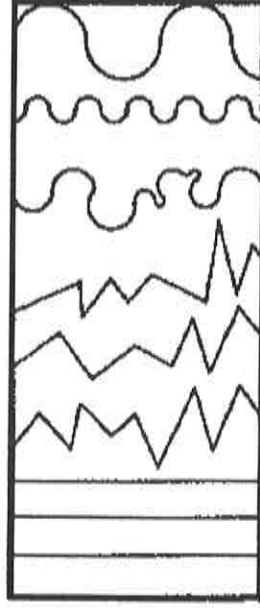

Fig. A-4

Cutting corners and sharp turns --- This is the most exciting part of owning a **Hawk** -- the flexibility to make cuts as intricate or as simple as you want. Your new **Hawk Ultra** can make a complete 360 degree turn in a project with less than 1/64" cutting radius. When cutting a project that requires sharp turns and points, here are a few helpful suggestions:

1. Start by making your cut all the way to the point where you want to make a sharp turn.
2. Now, without feeding your project forward into the blade, slowly spin the wood around the blade in its own "kerf". If you're used to sawing with a bandsaw or a jigsaw, you may be tempted to "set" the blade, **DON'T!** If you find that while cutting you tend to break blades often, or there is smoke while you are trying to make a turn or corner you're not alone. Many people have this problem, initially.
3. If your project clatters on the table or it tries to pull from your hands while making turns, you may want to go to a smaller blade and consider using the hold-down foot. The smaller the blade size, the smaller the turning radius capability. For very intricate projects, the smallest size blade that you are comfortable with is best. (See our blade recommendation chart on page 10-11).

LET'S MAKE A PROJECT

Now it's time to put what you have learned to work for you! Remember, begin at a corner of your pattern and cut across the grain when you first start. Follow the line around; if you're right-handed, you will probably be most comfortable feeding your project counter-clockwise (vice-versa for a left-handed scroller). It really doesn't matter which direction you cut. Go in the direction that feels most comfortable to you. Start at the outside of the pattern and work your way inward.

When cutting along the line, you can saw as fast or as slow as you want. You can adjust the variable speed knob speed up or slow your work down. If you're cutting and you start to wander from the line of the pattern, don't try to jerk back onto the line --- you'll just end up with a bumpy project. The best technique is the "near hit" method. In most cases you would have to wander more than 1/8" from your pattern line to make a noticeable variation.

Always remember that the blade of your new **Hawk Ultra** is stationary and you control your project. You must spin the wood --- the blade will not turn. This is how most people break blades when getting started. Remember, the saw blade has teeth on the front side only. Always remember to feed directly into the front of the blade --- never lean to the side. Let the blade do the cutting.

After you've completed your test project, step back and take look at your first success...CONGRATULATIONS! Look at the sides of the project and inspect for burn marks. If there are burn marks on your projects, you have room for improvement on feeding straight into the blade or you may need to switch to a different blade size. If your line seems a little bumpy, you'll want to concentrate on the "near hit" technique. Now you're ready to finish this project and get going again.

Be sure to read over the "Sawing Techniques" section for more tips and techniques on all types of cutting.

BLADES FOR EVERY OCCASION

There are literally hundreds of types, styles, and sizes of blades available for cutting most any material you choose. On the next two pages are charts that will help you better understand the most popular types and sizes of blades for your saw.

Fret Saw Blades

Originally designed for a hand fret saw, these blades are ideal for the power scroll saw. This is the best blade for general cutting. It is recommended for wood, plastics, rubber, fabric, paper, alabaster, and most other non-metallic materials.

Diamond Blades

The diamond blade is the newest and most unique blade yet. This blade is manufactured by impregnating a round rod with diamond chips. For crafters who enjoy making stained glass projects or do large amounts of ceramic and marble cutting, the diamond blade is the answer. The diamond blade must be used with the drip tank system to keep the blade wet at all times and keep it from loading up with glass particles which causes the blade to break.

Metal Cutting / Jeweler's Saw Blades

These blades are designed for use in the hand held jewelers saw frame still used frequently among jewelry designers. Its hardened steel composition and teeth configuration make it ideal for cutting both ferrous and non-ferrous metals such as gold, silver, steel, copper, brass, bronze, and aluminum.

Your new RBI Ultra Hawk uses standard 5 inch long, plain end (not pin end) scroll saw blades. Some of the many varieties and sizes are shown on the following pages. Make sure you use quality blades for best performance of your saw and achieve best results with your project. Experiment with the various types and sizes of blades to determine which works best for your application, cutting style and speed, and the type of material you are working with. Our blade guide is only a starting point, not a rule. Use the blade size you feel most comfortable with and gives you the best results.

HOW TO CHANGE A BLADE ON MODEL 216 HAWK ULTRA

Step #1 --- The rear cam-over handle has two positions: the released position (for changing blades), and the tensioned position (for sawing). The blade tension is adjusted with the cam-over handle on the back of the saw. Begin blade change by releasing the tension via the cam handle on the rear of the saw. By flipping the handle in the complete rear/released position, your blade tension will be released. Loosen the thumb screw on the upper blade holder to release the old blade.

Step #2 --- Choose the size and type of blade you will be using. Make your selection from the blade chart located on pages 10-11. The lower blade holder is located at the front of the bottom arm. To remove the lower blade holder, start by grasping the blade holder at both ends (with your thumb and index finger), remove it by pushing down slightly and sliding the blade holder forward.

Step #3 --- Now, let's mount the new blade in the bottom holder. There are two slotted holes in the front of the red saw base. Use one to hold the chuck while changing the blade. Place the lower blade holder in the slot so the chuck will not rotate when the thumb screw is turned. See diagram for blade positioning. Rotate the thumbscrew counterclockwise to release the old blade.

Step #4 --- Remove any remaining portion of the blade from the chuck. Make sure that all broken blade pieces are cleared away. With the teeth pointing forward and down toward the chuck (see diagram above), insert the new blade through the hole in the top of the bronze bushing and into the lower blade holder so the bottom end of the blade is touching the bottom of the hole in the chuck. The blade must come straight out of the chuck.

Step #5 --- Insert the chuck into the slot in the saw base again, and turn the thumb screw clockwise, thereby tightening the new blade in the chuck. Be careful not to over tighten the chuck --- more is not always better. When the blade is over tightened, you will crimp the blade and weaken it at the point where the blade enters the chuck. This will make the blade prone to breaking next to the blade holder. Undertightening will allow the blade to slip free from the chuck. Practice will be your best teacher as to how much is "enough". Be sure the teeth on the blade are facing the front of the saw and are pointing downward.(see diagram above).

Step #6 --- Remove the blade holder from the holding slot in the saw base and thread the blade up through the slot in the table. Slide the chuck back under the lower arm until the c-clip firmly grips the blade holder in the slot.

Step #7 --- Using your index finger, bring the upper arm down while pinching the blade between your thumb and second finger (see fig. A-8). Push the blade back into the slot in the front of the upper blade holder. Make sure the blade is completely to the back of the blade holder and the top of the blade is touching the stop pin. Tighten the blade holder knob with your right hand. Make sure that the blade is square with the upper blade holder.

Step #8 --- Now it's time to re-tension the blade. Almost every size and/or type of blade requires an alteration in the tension put on the blade. A good rule of thumb is this: when moving to a smaller blade, lighten the tension --- when moving to a larger blade, increase the tension. Note: Use the RBI Blade Tension Chart on the left rear side of the saw as a guide. **Step #9** --- With the rear cam-over handle in the released position, begin the tensioning process by rotating the tension rod either clockwise or counterclockwise and flipping the rear cam handle back to the tensioned or forward position. For specific instructions on the "clock method of tensioning", see pages 14 & 15. Stop tensioning when the blade makes a clear "ping" when plucked like a guitar string. For more information see **BLADE TENSIONING**.

Step #10 --- **You're finished changing the blade!** Congratulations! You're ready to get started sawing. Each time you change the blade, it will become easier. Soon, you will be changing blades in seconds.

Note: If you break a blade, simply move the rear cam handle to the released position (to release the blade tension) and change the blade. Return the rear cam handle to the tensioned position. The tension should be correct and should not need adjusting. (slight changes in blade length may require minor modification in tension adjustment).

The process of blade changing on the RBI HAWK ULTRA MODELS 220 AND 226 is very similar and will be explained in detail on the following pages.

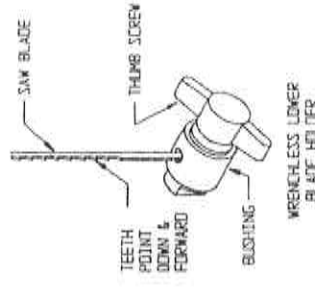

HOW TO CHANGE A BLADE ON MODELS 220 & 226 HAWK ULTRAS

Front Cam Benefits

By utilizing the front cam, the blade can be changed without getting off your stool or stretching to reach the back of the saw. This feature is great when making multiple inside cuts or for someone who is physically challenged. It's another example of how RBI is working to make your saw a more "user friendly" machine.

Here's an easy step-by-step method for changing the blade on your Hawk ULTRA 220 & 226.

Step #1 --- The front cam has two positions: the released position - for changing blades, (see fig. A-5) and the tensioned position - for sawing (see fig. A-6). The blade tension is adjusted with the cam-over handle on the back of the saw. Begin blade changing by releasing the front cam (black handle on the left side of the upper arm). By flipping the handle in the complete forward position, your blade tension will be released. Loosen the thumb screw on the upper blade holder to release the old sawblade.



Fig. A-5

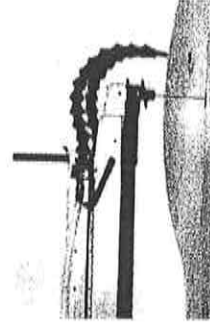
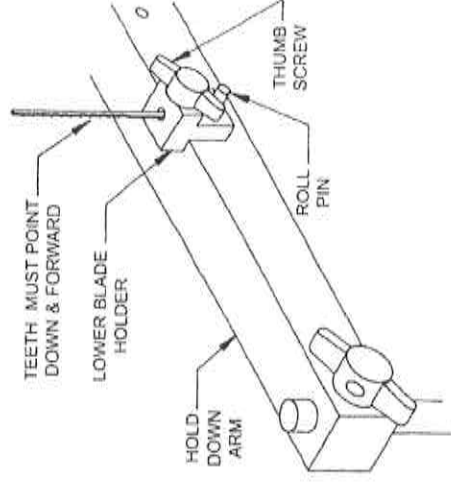

Fig. A-6

Step #2 --- Choose the size and type of blade you will be using. (Make your selection from the blade chart located on pages 10-11).

The lower blade holder is located at the front end of the lower arm. By holding the blade holder at both ends (with your index finger and thumb), you can remove it by pushing down slightly and sliding the blade holder forward.

Step #3 --- Now, let's mount the blade in the bottom blade chuck. The lower blade holder is "T" shaped when viewed from the front. It has a pin through the bottom and a thumb screw to clamp the blade. To hold the chuck while changing blades, there are two holes in the hold down arm. Only one hole is needed; there is an extra. Place the lower blade holder against the hold down arm with the pin in the hole and the top portion over the hold down arm (see figure at right) so the blade will not rotate when the thumb screw is turned.



Step #4 --- Remove any remaining portion of the old blade and saw dust from the chuck. Make sure that all broken blade pieces are cleared away. With the teeth pointing forward and down toward the front of the chuck, insert the new blade through the hole in the top of the of the lower blade holder so the bottom end of the blade is touching the bottom of the hole in the chuck. The blade must come straight out of the chuck.

Step #5 --- Using the thumb screw, tighten the new blade in the chuck. Be careful not to over tighten the chuck --- more is not always better! When the blade is "over tightened", you will crimp the blade and weaken it at the point where the blade enters the chuck. This will make the blade prone to breaking next to the blade holder.

Step #6 --- Remove the blade holder from the hold down arm and thread the blade up through the slot in the table. Be sure the teeth on the blade are facing the front of the saw. (See Fig. A-7). Slide the chuck back under the lower arm in the slot. There are two notches in the lower arm for the lower blade holder to fit into. The front one is for thinner stock --- (1-1/2" and under), and the back notch is for thicker stock (see figure on the next page).

Step #7 --- Using your index finger, bring the upper arm down while pinching the blade between your thumb and second finger (see fig. A-8). Push the blade back into the slot in the front of the upper blade holder. Make sure the blade is completely to the back of the blade holder and the top of the blade is touching the stop pin. Tighten the blade holder knob with your right hand. The blade should be square with the upper blade holder.

Step #8 --- Now it's time to begin re-tensioning the blade. Almost every size and/or type of blade requires an alteration in the tension put on the blade. A good rule of thumb is this: when moving to a smaller blade, lighten the tension --- when moving to a larger blade, increase the tension.

Step #9 --- Begin the tensioning process by flipping the front cam back to the tensioned position. Now begin tensioning the blade with the rear cam by slowly moving the rear cam-over handle back to the original position. Adjusting the tension is done with the rear cam. Stop tensioning when the blade makes a clear ping when plucked like a guitar string. For more information see **BLADE TENSIONING**. Follow the blade tension chart guidelines located of the left rear of your saw.

Step #10 --- **You're finished changing the blade!** Congratulations! You're ready to get started sawing. Each time you change the blade, it will become easier. Soon you'll be changing blades in seconds, and the more experienced you are, the longer the life of each blade that you are using.

Note: If you break a blade, simply move the front cam handle to the released position (to release the blade tension) and change the blade. Return the front cam handle to the tensioned position. The tension should be correct and should not need adjusting.

VARIABLE SPEED CONTROL

SPEED CORRELATION CHART		
NO.	SPEED	NO. SPEED
#1	300 RPM	#6 1200 RPM
#2	500 RPM	#7 1325 RPM
#3	725 RPM	#8 1500 RPM
#4	850 RPM	#9 1650 RPM
#5	1025 RPM	#10 1725 RPM

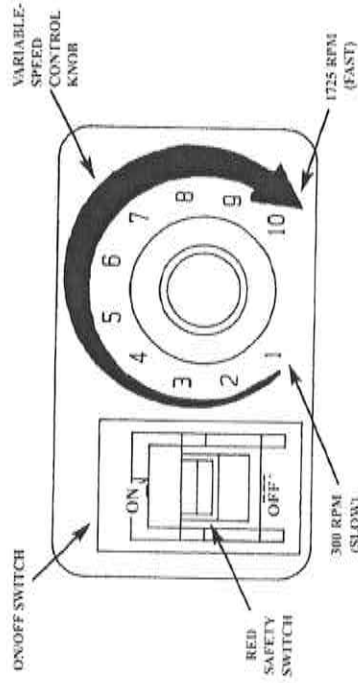

BLADE TENSIONING

To adjust the blade tension, release the cam-lock at the rear of the saw by flipping the cam handle toward the back, or away from the front of the saw. This will release blade tension.

Clock Method: If you look at the saw from the left side (rear cam-lock at your left hand) imagine the cam-over handle as the hour hand of a clock. If you look at the chart on the following page, you will see the cam-handle in the straight up or 12 o'clock position. The object here is to set the point at which tension starts as you lift the cam-handle toward the front of the saw with the suggested clock position in the chart. To change the point at which tension starts, you grasp the tension rod and either turn it clockwise or counter-clockwise. Turning it clockwise will reduce the tension (make the cam stop at a higher clock position) and turning it counter-clockwise will increase the tension (make the cam stop at a lower clock position).

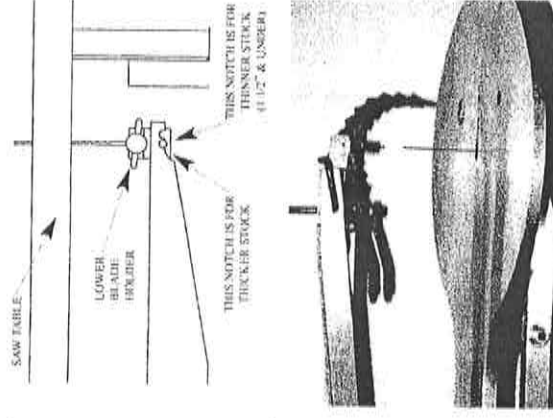

Fig. A-7



Fig. A-8

Once you have tension starting at the correct clock position, pull the rear cam-over handle all the way over toward the front of the saw and the tension will be set at the correct pressure for each blade. (If you have questions, view the Hawk Scroll Saw Video for a visual demonstration). The positions in the diagram below are to be used as a reference point only. You may use a little more or a little less tension depending on your preference and cutting style.

BLADE TENSION CHART			
BLADE SIZE	CLOCK POSITION	# 216	# 220 # 226
#12	11:30	11:00	10:30
#9	11:30	11:00	10:30
#7	12:00	11:30	11:00
#5	12:30	12:00	11:00
#2	1:00	12:30	12:00
#2/0	1:00	1:00	12:30

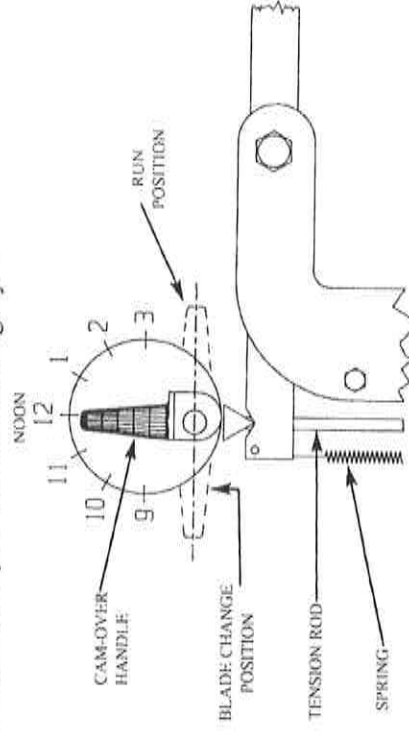

BLADE CHANGING AND TENSION ADJUSTMENT DIAGRAM

ADVANCED SCROLL SAWING

Bevel Sawing

Bevel Sawing is a fun way to add another dimension to a project. To make a bevel cut, simply tilt the table of your Hawk and begin cutting. Many crafters use the bevel sawing technique to create inlays and 3-D pictures like the one we'll make for this project.

Make a copy of the "*Desert Pattern*" from your RBI Pattern Pak and attach it, by the method of your choice, to a piece of 1/2" wood --- just about any kind of wood will work.

Tilt the saw table approximately three degrees to the left. Beginning with the most inside line (in this case, it's the desert floor and cactus), make the first cut, following the direction of the arrows.

For the second cut, follow the next pattern line (the ground and mountains), again going the direction of the arrows.

For the final cut, follow the last line, again, going in the direction of the arrows. Push each piece into position to make a fun 3-D project.

The bevel cutting technique may also be used for making all types of inlays. There is a detailed pattern in your RBI Pattern Pak for complete instructions on making inlays.

NOTE: If you are tilting the table more than 40 degrees to the right, the lower blade holder must be reversed so the thumb screw is on the left side of your lower arm. This will allow the thumb screw to clear the saw table. (See picture below) The blade holder and the blade itself will have to be reversed to accomplish the 40 degree plus bevel to the right.

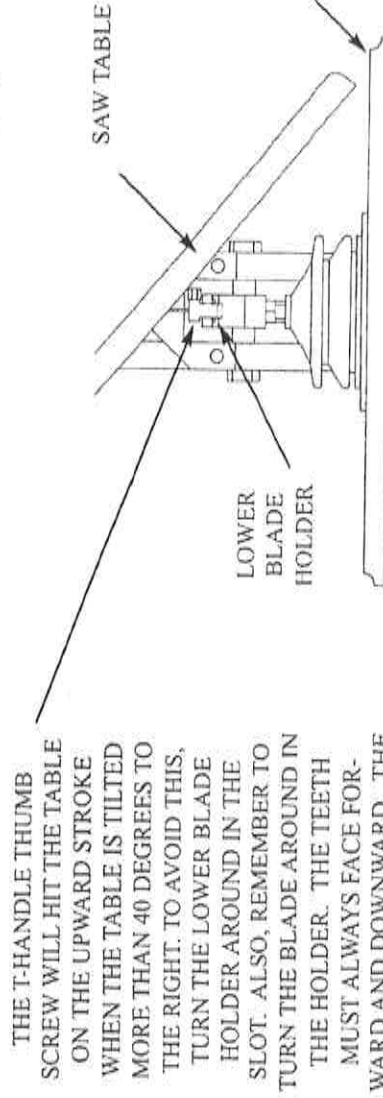

NOTE: THE TABLE TILT & BASE TILT WERE REMOVED FOR CLARITY

Stack Cutting

This is a technique most pros use when they are making several projects of the same pattern. Your Hawk has the ability to cut up to a full 2-5/8" thick material, so you can stack most projects at least 2" high. There are many ways to keep the projects from slipping while cutting. Here are a few of our favorites:

- : **Hot Melt Glue** --- Many times when pros are cutting they use a hot glue gun to glue all the pieces together. They put the pieces together in a stack (remember, not more than 2"), and run a bead of glue in a zigzag down two sides of the project material. By making a zigzag, the material will hold together when cutting in any direction.
 - : **Double Sided Tape** --- Some Hawk owners tell us that they think the glue is messy and they prefer to use carpet layer's double stick tape. To hold your project together with tape, you just sandwich a couple of strips between each layer and you're ready to go.
 - : **Masking Tape** --- Simply wrap the corners, thereby sandwiching multiple pieces together. Remove the tape when completed and lightly sand to remove any sticky tape residue.
 - : **Nails** --- We've even talked to some real purists that prefer to stick with traditional woodworking item and just stack'em up and nail'em. If you use this method, **be sure your nails are not sticking out of the projects** or they will scratch and mar the table surface. This is the most solid way to hold your stack together. Make sure your nails are in the waste area of the project.
- NOTE: USE A METHOD WHICH WORKS BEST FOR YOUR APPLICATION!**



Fig. A-10

To practice the technique of stack cutting we will make a pair of identical shelf support brackets. For this project you will need two pieces of 1" x 8" lumber. Any kind of wood will do --- either hard or soft wood. Make sure both pieces are the same size. Stack them up and lock them together the way you like best. Now put your project to the side --- we've got another technique to learn before we can start cutting your project.

Note: Always make sure your table top is completely square before making a stack cut project or you will find that the projects will be smaller on the bottom than they are on the top. This is a perfect application for use of the RBI precision blade square. (see page 31)

Inside Cuts

Making an inside cut is simply cutting an opening in your project without making an entry cut. Making inside cuts is impossible with the band saw, but the Hawk can make them in a snap! First, begin by drilling a hole in the scrap area which is to be removed. Make sure the hole is big enough for the blade to fit through.

You will need to release the tension on the blade. Remember the front cam tension release lever? (It's the little black lever on the left front side of the upper arm.) Flip the front cam lever all the way to the front. This should release the tension on the blade. Now remove the blade from the upper blade holder by unscrewing the knob on the right side of the upper blade chuck (see Fig. A-11).

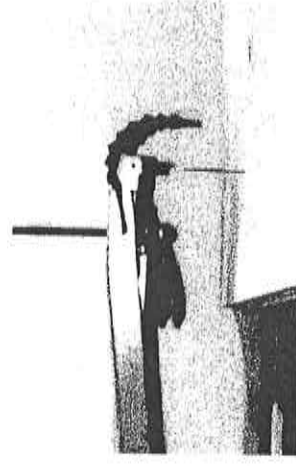

Fig. A-11

Tilt the blade forward to the front of the slot in the table and thread the blade through the hole you drilled in the wood. You're now ready to replace the blade in the upper blade chuck and put your front tension cam lever back in its rear or tensioned position (see fig. A-12).

After you have made your cut, release the blade tension again, remove the top end of the blade from the top blade holder, and remove the workpiece. You did it!

Here's where your project comes in --- there's a few inside cuts. You need to drill a hole in the shaded area of the pattern and follow the instructions above for technique. Be sure to cut all shaded sections in the pattern. Now you've made the brackets into a beautiful gingerbread style shelf! These are great to use as shelf brackets, or you might even want to finish them in a window or doorway just to add a warm touch.

Compound Sawing

This is probably the toughest technique to learn for most crafters, but making a compound cut can certainly be rewarding when you finally master it. By cutting all four sides of a project you add a completely new dimension to a simple project. We've enclosed a pattern for one of our favorite Christmas tree ornaments for you to try.

To begin your compound cut project you will need a 2" x 2" x 4" piece of soft wood. Our favorite is basswood, but pine will work very similar. Begin by taking the face pattern (the one that looks like you're looking at a reindeer head on), and attach the pattern (the one that looks like the profile of a reindeer), and glue it on the adjoining side. Now using the cutting techniques you've already learned, cut out the face pattern. Be sure to keep all the pieces if they separate.

After you have made the entire face cut, carefully put all of the pieces together and tape them securely back in their original place with masking tape. Next, take the profile pattern and cut it out in the same way you did the face pattern. After you take all the pieces apart you will find a perfectly dimensioned reindeer inside. (This is a fun way to make brain teaser puzzles.) Some wood carver's tell us that they like to cut out their blanks first by compound cutting, then they finish them with wood carving tools.

TROUBLESHOOTING

If you're getting a little frustrated, here are some troubleshooting tips that might help.

: Excessive Blade Breakage

If you think you are breaking an excessive amount of blades, here are a few tips:

- A. Be sure you are using the right size and type of blade for the material you are trying to cut. You can make sure by checking the blade recommendation chart on pages 10-11.
- B. If the blade tends to break right above the bottom blade chuck, your blade is not installed in the lower blade chuck correctly. Helpful hint: be sure the blade is coming straight out of the blade chuck as pictured on page 12 or 13. Remember --- when tightening the blade, don't over tighten. If you tighten the chuck too tightly, you'll crimp the blade and weaken it just above the blade chuck. This will cause the blade to break.
- C. If the blade is breaking just below the upper blade chuck, chances are that you are not installing it in the upper blade chuck correctly. Remember --- The blade must be all the way to the back of the slot and the top of the blade must be touching the roll pin. The blade should be square with the upper blade holder.

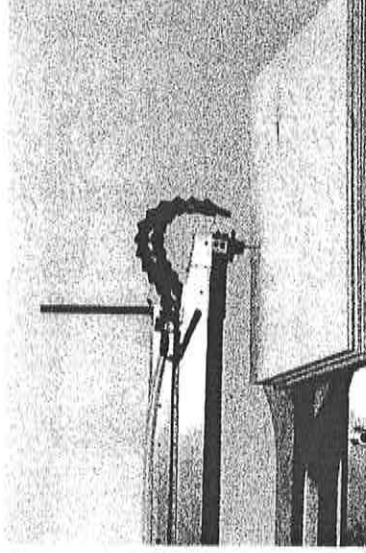

Fig. A-12

: Excessive Blade Breakage Continued

D. If the blade is breaking in the middle, your blade is probably installed just fine. After you've been sawing for a while, you'll find your blade life will increase. Some folks call us and say that they've cut for so many hours that they have worn the teeth right off the front of the blade. If you're like most sawyer's starting out, you should expect about 15 to 30 minutes cutting for a blade. After the first few weeks you'll find that time increasing. To get the longest possible life from the blade, here are a few tips:

1. Always remember to drive the wood, not the blade. If you have trouble getting your saw to turn and it smokes while cutting, often that signifies that you need to practice your technique. Feed straight into the front of the blade.
2. If you have poor control of your blade and it seems to wander and respond very slowly, you might not have quite enough tension on the blade.

Here's a test: Install a #5 blade in your saw. Take a 1" piece of lumber and slide it across the table of your saw. When the blade touches the wood, draw a line across the saw table 1" on both sides of the blade. Now applying about 15 lbs. of pressure, push evenly into the blade with the wood. Draw another line parallel with the first one. There should be 3/16" between the two parallel lines. If there is more or less than that distance, adjust the tension with the rear cam by releasing it and turning it like a knob.

: Blade is Burning the Wood

1. Make sure you're using the right size and type of blade for the project. (See blade selection chart on pages 10-11.)
2. It may take a little practice, but you're leaning on the blade side to side when cutting. Remember that it's the project that moves --- not the blade. Your cutting surface is on the front side of the blade only.
3. Some woods just seem to be more prone to burning than others. Of course, hardwood like oak and walnut will burn if cut at too high of a RPM speed. Take advantage of your variable speed saw and slow it down. Slower speeds are recommended for metals, glass, plastics, some harder woods, and thin metals. Cherry and mahogany are difficult woods to cut without burning because of their resin content.

: Blade Keeps Bending and Twisting

1. If your blade is bending backwards farther than you feel it should, check your tensioning by doing the test listed under **Excessive Blade Breakage**.
2. You might be using the wrong size blade for the project. If your blade seems to be twisting when making sharp turns, go to the next smaller size blade.

: Blade is Cutting Too Large of a Radius

When most crafters get started, they have a little difficulty making sharp turns. Here are a few pointers you'll want to keep in mind:

- A. Feed your project right to the point where you want to make the turning point and stop feeding. Now without feeding the wood into the blade, spin the project around in the sawblade radius or kerf.
- B. If your blade tends to "swing" out when attempting a sharp point, you may have to increase the tension to the blade.

: Wood is Jumping on Table

1. Constant down pressure must always be applied while cutting. In most cases the weight of your hand is more than enough to keep the project on the table, but you must maintain the pressure during the entire cutting process.
2. If you prefer, every Hawk comes complete with a hold down foot that surrounds the blade and keeps the project securely on the table. (Be sure you have lowered the hold down foot to lightly touch the top of the wood surface.)
3. You may find that you are using a blade that is too large for the type of cutting you are doing. If the blade is too coarse, the project will lift from the worktable when making turns. In addition, when using a reverse tooth blade, the reverse teeth will give added lift to your project on the upward stroke. Additional downward pressure or use of the hold-down foot may be needed.

: Saw Does Not Start Immediately When Switch Is Turned On

Your new Hawk is equipped with a "soft start" motor/controller assembly. This short time delay after the switch has been turned on, allows for the electrical system to become fully charged before coming up to full power or speed, thereby reducing motor burnout. It is also a safety factor in that it allows the operator time to return both of his hands to the project before full speed is achieved. Soft start is the preferred operating procedure on better quality machinery.

You Can Reach Us

By Phone 1-620-562-3557

By Fax 1-620-562-3557

By Web jnye@hawkwoodworkingtools.com

ORDERING REPLACEMENT PARTS AND ACCESSORIES

To speed delivery and reduce errors when ordering parts always give the name, model number, and a serial number of your machine. Use the part number and description as shown in the parts list. Do not use the key numbers (the numbers in the circles on the parts breakdown drawing), always use the seven digit part number and the description given in the parts list.

1. Give Complete Machine Identification:

- A. Machine Name _____
- B. Model Number _____
- C. Serial Number _____

2. Seven Digit Part Number and Name:

- A. 7-Digit Part Number _____
- B. Part Name _____

3. State Your Return Address:

Your Name _____
Company _____
Street Address _____
P.O. Box: _____
City _____ State _____ Zip _____
Telephone (____) _____

PARTS BREAKDOWN
216 ULTRA HAWK

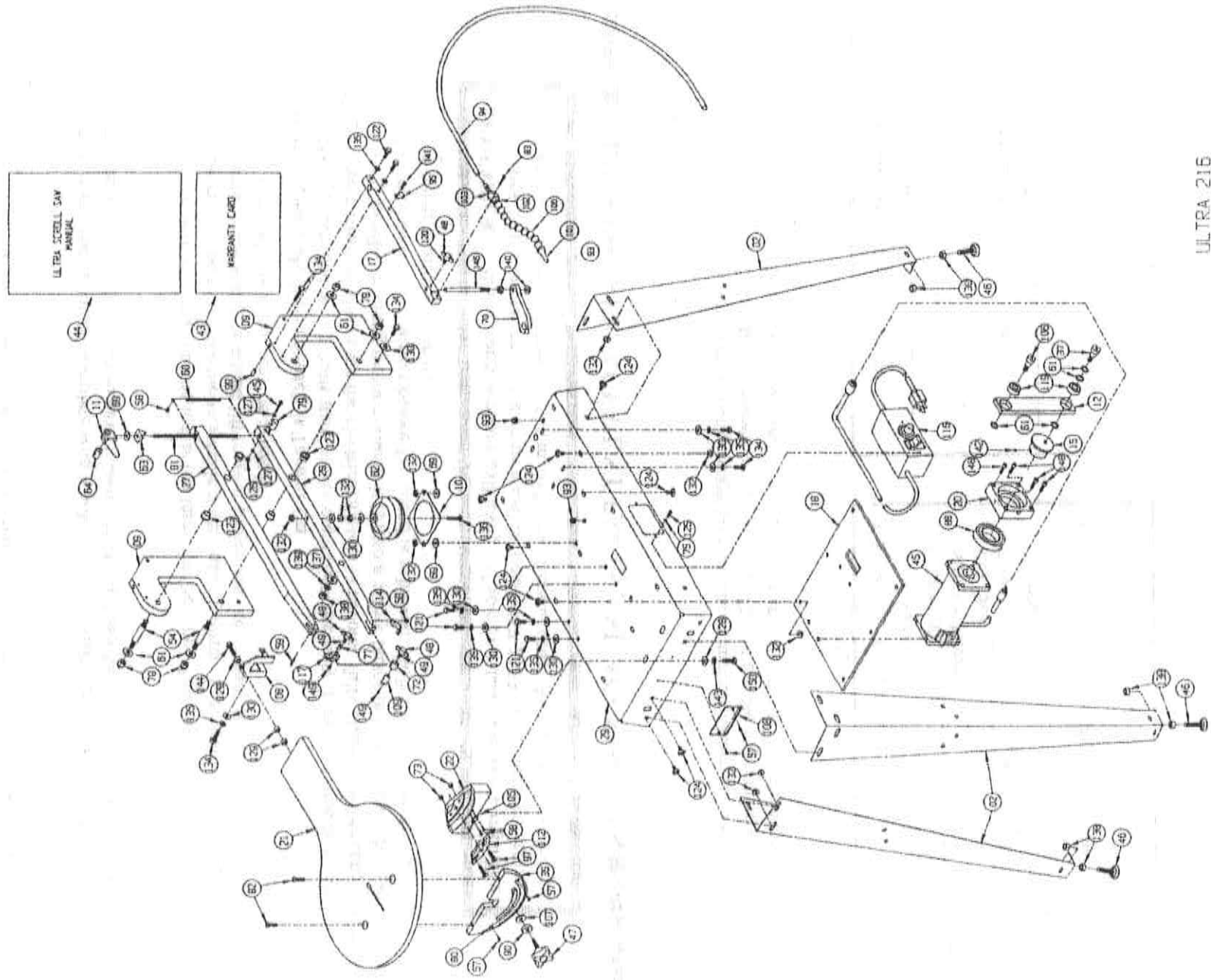

ULTRA 216

PARTS LIST MODEL 216 ULTRA HAWK

To speed up delivery an reduce errors when ordering parts always give the name, model number, and serial number of your machine. Use the part number and description as shown in the parts list. Do not use the key number (the numbers in the circles on the parts breakdown drawing). Always use the part number and description given in the parts list.

Key #	Part #	Description	Qty	Key #	Part #	Description	Qty
002	600-2007	ULTRA SCROLL SAW LEG	4	082	715-0244	1/4-20 X 3/4 FLAT HEAD SOCKET CAP SCREW	2
008	615-0113	REAR TABLE SUPPORT BRACKET, ULTRA 216	1	083	715-0247	8-32 X 1 ROUND HEAD MACHINE SCREW	1
009	615-0115	ARM SUPPORT, ULTRA216	2	088	715-0262	CARRIER BEARING, ULTRA SAWS	1
010	615-1025	BLOWER BELLOWS BRACKET	1	090	715-0268	KNOB SPACER (TABLE TILT-ULTRA SAWS)	1
011	615-1074	REAR CAM-OVER HANDLE, ULTRA SAWS	1	095	715-0273	RUBBER GRONNETT, 3/8" ID	1
012	615-1174	FITMAN ARM, 5-13/16", ULTRA 216	1	094	715-0274	POLYETHYLENE TUBING, 3/8" OD	1
015	615-1263	COUNTERWEIGHT, ULTRA SAWS	1	095	715-0275	NYLON CABLE CLAMP, ULTRA SAWS	34
017	615-2106	HOLD-DOWN ARM, ULTRA 216	1	097	715-0292	10-32 X 3/4 FLAT HEAD SOCKET CAP SCREW	1
018	615-2222	MOTOR BRACE, ULTRA SAWS	1	099	715-0295	RUBBER CAP 307" X 1/2"	2
020	615-2261	CARRIER BEARING CRADLE, ULTRA SAWS	1	100	715-0298	LOC-LINE 1/4" SEGMENT (BLACK)	1
021	615-3004	SMALL SAW TABLE, ULTRA 216	1	101	715-0299	LOC-LINE 1/8" ROUND NOZZLE (BLACK)	1
022	615-3021	SHORT BASE TILT, ULTRA 216	1	102	715-0307	LOC-LINE 1/4" NPT CONNECTOR (BLACK)	1
027	615-5001	TOP ARM, ULTRA 216	1	103	715-0308	FEMALE PIPE THREAD / HOSE BARB (BLACK)	1
028	615-5006	BOTTOM ARM (SOLID), ULTRA 216	1	104	715-0310	DECAL, WARNING-DO NOT EXPOSE TO	1
029	615-5111	SAW BASE, ULTRA 216	1	105	715-1101	SCROLL SAW POINTER	1
035	615-7020	TABLE TILT, SOLID, ULTRA 216	1	106	715-1109	1/2 X 1 ROUND HEAD SHOULDER BOLT	1
037	625-0033	1/2 X 1/2 SOCKET HEAD SHOULDER BOLT	1	107	715-1120	5/16" ID X 7/8" OD X 1/8" NYLON SPACER	1
039	702-0002	DECAL, RBI MADE IN USA (ROUND)	1	108	715-1122	SERIAL TAG, ULTRA 216 SCROLL SAW	1
040	702-0011	DECAL, KEEP FINGERS FROM UNDER ARM	1	109	715-1186	LOWER BLADE HOLDER, BARREL STYLE	1
041	702-0025	DECAL, PATENT #4,848,761	1	111	715-1259	VARIABLE SPEED CONTROLLER, 90 VDC 60 HZ	1
042	702-0034	DECAL, RBI BLADE TENSION CHART	1	112	715-1288	BASE/TABLE TILT SLIDE (DELRIN)	1
043	703-0700	WARRANTY CARD, GENERAL	1	114	715-2138	BLADE HOLDER C-CLIP (BARREL TYPE)	1
044	703-5729	MANUAL, ULTRA SAWS 216-220-226	1	117	715-5181	ULTRA-ALUMINUM UPPER BLADE HOLDER	1
045	704-1013	MOTOR, 1/5 HP, 90 VDC, 60 HZ	1	119	735-0007	1/2" ID BALL BEARINGS	2
046	705-0057	GLIDE	4	120	735-0017	1/4-20 X 3/4 SOCKET HEAD CAP SCREW	1
047	705-1042	5/16-18 X 1-1/4 SQUARE KNOB	1	121	735-0052	1/4-20 X 1 HEX HEAD BOLT	4
048	707-6030	1/4 TEE KNOB	3	122	735-0080	1/4-20 X 1-1/4 HEX HEAD BOLT	2
049	707-6286	1/4-20 X 1/2 SOCKET HEAD CAP SCREW	2	123	740-0369	1/2" ID FLANGED BRONZE BUSHING	4
050	709-0096	DECAL, CONSULT TECHNICAL MANUAL	1	124	745-0099	1/4-20 X 5/8 CARRIAGE BOLT	2
051	709-0097	DECAL, CAUTION - CUTTING OF FINGERS	1	125	745-0106	10-32 X 1/2 ROUND HEAD MACHINE SCREW	20
052	709-0098	DECAL, WEAR EYE PROTECTION	1	126	745-0107	10-32 HEX NUT	2
053	709-0099	DECAL, LIGHTENING BOLT/SHOCK	1	127	745-0112	3/16" ID X 1/2" OD RIVET BURR	1
054	809-0113	BOLT, SAW ARM PIVOT, ULTRA 216/220	2	128	745-0150	5/16" FLAT WASHER	2
057	710-0012	#7 X 5/16 ROUND HEAD DRIVE SCREW	4	129	745-0158	5/16" ID X 1/2" OD X 3/16" NYLON SPACER	3
058	710-0035	10-32 X 1/4 ROUND HEAD MACHINE SCREW	1	128	745-0177	1/4 FLAT WASHER	12
059	710-0042	1/8 X 3/4 ROLL-TENSION PIN	4	130	745-0205	DECAL, MADE IN THE USA (OCTAGON)	1
060	710-2036	SAW ARM SAFETY SPRING	1	131	745-0223	1/4-20 FLANGED LOCK/W/WHIZ NUT	1
061	715-0014	1/2" ID X 3/4" OD X 18 GUAGE WASHER	1	132	745-0296	1/4-20 X 3/4 HEX HEAD BOLT	20
062	715-0024	RUBBER BLOWER BELLOWS	12	133	750-0207	1/4 SPLIT LOCK WASHER	7
063	715-0075	ALUMINUM WEDGE PIVOT	1	136	750-0213	1/4-20 X 2 CARRIAGE BOLT	12
064	715-0077	ROUND PIVOT, REAR CAM-OVER HANDLE	1	137	770-0050	3/8 FLAT WASHER	1
065	715-0078	1/4-20 NYLON INSERT LOCK HEX NUTS	1	138	770-0058	3/8-16 HEX NUT	1
066	715-0091	DECAL, SCROLLER'S HOTLINE	1	139	770-0071	3/8 SPLIT LOCK WASHER	9
067	715-0092	DECAL, RBI HAWK	1	140	770-0080	3/8 SPLIT LOCK WASHER	1
069	715-0103	1/4" ID X 3/4" OD X 1/16" NYLON SPACER	3	141	770-0088	8-32 X 1/2 ROUND HEAD MACHINE SCREW	2
070	715-0104	HOLD-DOWN FOOT, ULTRA SCROLL SAWS	1	142	770-0095	1/4-20 X 1/4 SKT SET SCREW, KNURLED CLIP PT	1
071	715-0107	WIRE TIE, 6-3/4" TO 7-3/4" LONG	1	143	770-0178	5/16 SPLIT LOCK WASHER	2
072	715-0112	BUSHING, LOWER BLADE HOLDER	1	144	770-0181	5/16-18 X 1 HEX HEAD BOLT	1
073	715-0163	10-32 ACORN CAP NUT	2	145	780-0819	10-32 X 1 ROUND HEAD MACHINE SCREW	1
075	715-0191	3/16 INTERNAL LOCK WASHER	2	148	785-2012	HOLD-DOWN FOOT ROD, 6 INCH	1
077	715-0205	1/2-13 NYLON INSERTED LOCK NUT	1	148	790-0059	1/4-20 X 1-1/4 SOCKET HEAD CAP SCREW	4
078	715-0210	ROUND PIVOT, BOTTOM ARM (REAR)	1	149	791-0053	1/4-20 X 1/4 SOCKET SET SCREW, FLAT POINT	2
079	715-0216	TABLE TILT SCALE, ALUMINUM	1	150	795-0063	5/16-18 X 3/4 HEX HEAD BOLT	2
080	715-0236	TENSION ROD, 9-3/8" LONG	1				
081	715-0272		1	965-2900	SAW LEG ASSEMBLY		1
				615-1182	ULTRA UPPER BLADE HOLDER ASSEMBLY		1
				615-1187	WRENCHLESS LOWER BLADE HOLDER ASSY.		1
				615-1251	ULTRA BOLT BAG ASSEMBLY		1

PARTS BREAKDOWN
220 ULTRA HAWK

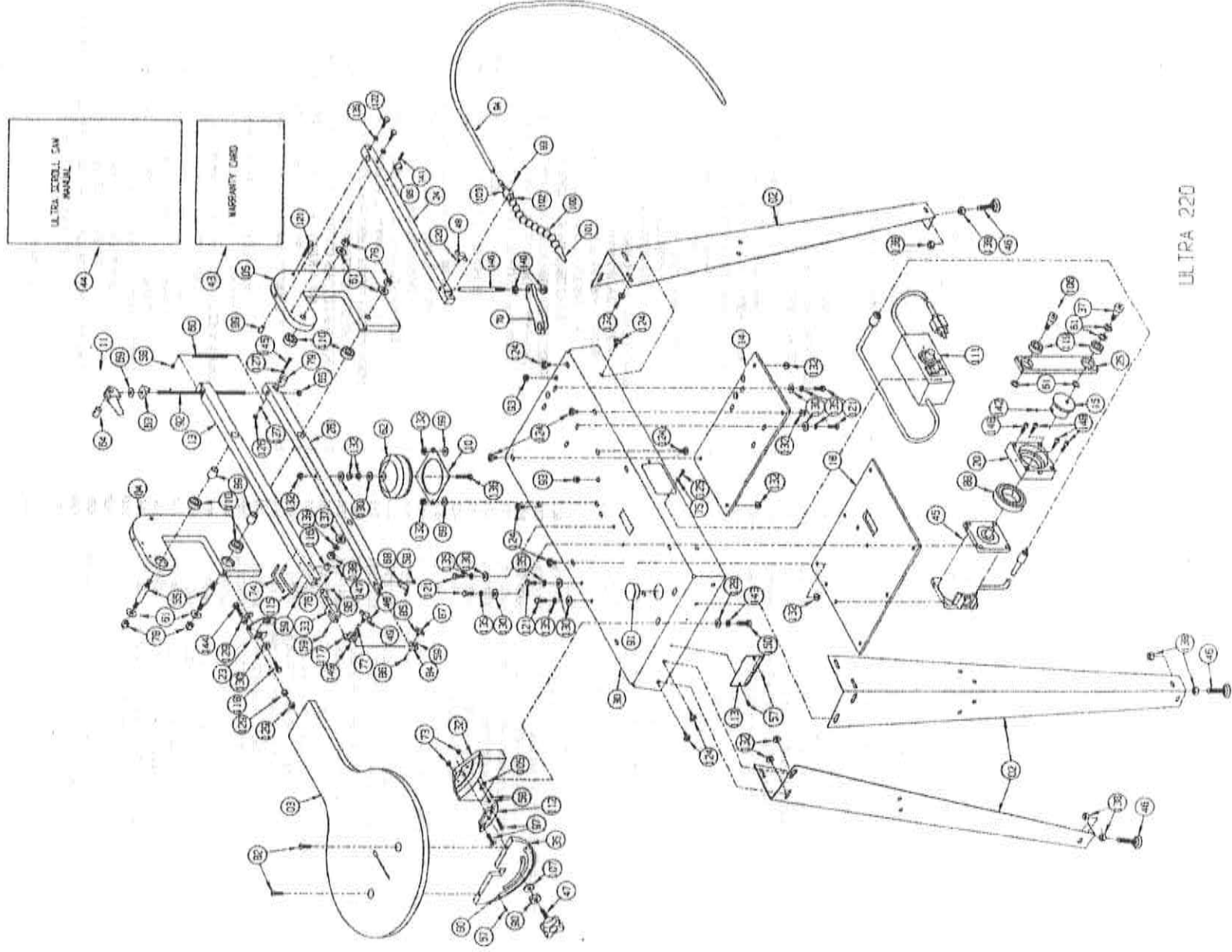

PARTS LIST MODEL 220 ULTRA HAWK

To speed up delivery an reduce errors when ordering parts always give the name, model number, and serial number of your machine. Use the part number and description as shown in the parts list. Do not use the key number (the numbers in the circles on the parts breakdown drawing). Always use the part number and description given in the parts list.

Key #	Part #	Description	Qty	Key#	Part#	Description	Qty
002	600-2007	ULTRA SCROLL SAW LEG	4	083	715-0247	8-32 X 1 ROUND HEAD MACHINE SCREW	1
003	605-5005	LARGE SAW TABLE, ULTRA 220/226	1	084	715-0252	ULTRA LOWER BLADE HOLDER (ALUMINUM)	1
004	609-0013	ARM SUPPORT, ULTRA 220, LEFT	1	085	715-0255	10-32 X 1/2 SOCKET HEAD CAP SCREW	1
005	609-0014	ARM SUPPORT, ULTRA 220, RIGHT	1	086	715-0256	10-32 X 3/16 SOCKET SET SCREW, FLAT POINT	1
010	615-1025	BLOWER BELLOWS BRACKET	1	087	715-0257	PLASTIC T-HANDLE (#10)	1
011	615-1074	REAR CAM-OVER HANDLE, ULTRA SAWS	1	088	715-0262	CARRIER BEARING, ULTRA SAWS	1
013	615-1212	TOP ARM, ULTRA 220	1	089	715-0264	POWDERED METAL BRG: 1/2" ID X 5/8" OD X .073"	2
014	615-1260	ARM SUPPORT BRACE, ULTRA 220	1	090	715-0268	KNOB SPACER (TABLE TILT-ULTRA SAWS)	1
015	615-1263	COUNTERWEIGHT, ULTRA SAWS	1	091	715-0271	DUST PORT PLUG, ULTRA 220/226	1
018	615-2222	MOTOR BRACE, ULTRA SAWS	1	092	715-0272	TENSION ROD, 9-3/8" LONG	1
020	615-2261	CARRIER BEARING CRADLE, ULTRA SAWS	1	093	715-0275	RUBBER GROMMET, 3/8" ID	2
023	615-4211	REAR TABLE SUPPORT BRACKET ULTRA 220	1	094	715-0274	POLYETHYLENE TUBING, 3/8" OD	45
024	615-3215	HOLD-DOWN ARM, ULTRA 220	1	095	715-0275	NYLON CABLE CLAMP, ULTRA SAWS	1
025	615-4193	FITMAN ARM, ULTRA 220/226	1	096	715-0287	10-32 X 1/4 SKT. ST. SCR., BRASS W/ NYL. INSERT	1
026	615-4213	BOTTOM ARM, ULTRA 220	1	097	715-0292	10-32 X 3/4 FLAT HEAD SOCKET CAP SCREW	2
030	615-5217	SAW BASE, ULTRA 220	1	099	715-0295	RUBBER CAP, 207" X 1/2"	1
032	615-6027	TALL BASE TILT, ULTRA 220/226	1	100	715-0298	LOC-LINE 1/4" SEGMENT (BLACK)	1
033	615-6153	TOP BLADE HOLDER, BRACKET, ULTRA 220/226	1	101	715-0299	LOC-LINE 1/8" ROUND NOZZLE (BLACK)	1
035	615-7020	TABLE TILT, SOLID, ULTRA SAWS	1	102	715-0300	LOC-LINE 1/4" NPT CONNECTOR (BLACK)	1
037	625-0023	1/2 X 1/2 SOCKET HEAD SHOULDER BOLT	1	103	715-0306	FEMALE PIPE THREAD / HOSE BARB (BLACK)	1
039	702-0002	DECAL, RBI MADE IN USA (ROUND)	1	104	715-0310	DECAL, WARNING: DO NOT EXPOSE TO	1
040	702-0011	DECAL, KEEP FINGERS FROM UNDER ARM	1	105	715-1101	SCROLL SAW POINTER	1
041	702-0025	DECAL, PATENT #4,848,761	1	106	715-1109	1/2 X 1 ROUND HEAD SOCKET SHOULDER BOLT	1
042	702-0034	DECAL, RBI BLADE TENSION CHART	1	107	715-1120	5/16" ID X 7/8" OD X 1/8" NYLON SPACER	1
043	703-0700	WARRANTY CARD, GENERAL	1	110	715-1208	THRUST BEARING, SHIELDED	4
044	705-5729	MANUAL, ULTRA SAWS 216-220-226	1	111	715-1259	VARIABLE SPEED CONTROLLER, 90 VDC, 60 HZ	1
045	704-1013	MOTOR, 1/5 HP 90 VDC, 60 HZ	1	112	715-1288	BASE/TABLE TILT SLIDE (DELRIN)	1
046	705-0057	GLIDE	4	113	715-2070	SERIAL TAG, ULTRA 220 SCROLL SAW	1
047	705-1042	5/16-18 X 1-1/4 SQUARE KNOB	1	115	715-2168	ULTRA FRONT CAM HANDLE (220/226)	1
048	707-6030	1/4 TEE KNOB	2	116	715-3154	ROUND FRONT CAM (220/226)	1
049	707-6286	1/4-20 X 1/2 SOCKET HEAD CAP SCREW	1	117	715-5181	ULTRA ALUMINUM UPPER BLADE HOLDER	1
050	708-0096	DECAL, CONSULT TECHNICAL MANUAL	1	118	725-0043	1/4-20 X 1/2 HEX HEAD BOLT	9
051	709-0097	DECAL, CAUTION, CUTTING OF FINGERS	1	119	735-0007	1/4-20 X 1-1/4 HEX HEAD BOLT	2
052	709-0098	DECAL, WARN EYE PROTECTION	1	124	745-0099	1/4-20 X 5/8 CARRIAGE BOLT	24
053	709-0099	DECAL, LIGHTNING BOLT/SHOCK	1	120	735-0017	1/4-20 X 3/4 SOCKET HEAD CAP SCREW	1
055	709-0123	BOLT, SAW ARM PIVOT, ULTRA 216/220	2	121	735-0052	1/4-20 X 1 HEX HEAD BOLT	1
057	710-0012	#7 X 5/16 ROUND HEAD DRIVE SCREW	4	122	735-0080	1/4-20 X 1-1/4 HEX HEAD BOLT	2
058	710-0035	10-32 X 1/4 ROUND HEAD MACHINE SCREW	4	125	745-0166	10-32 X 1/2 ROUND HEAD MACHINE SCREW	2
059	710-0042	1/8 X 3/4 ROLL/TENSION PIN	3	126	745-0107	10-32 HEX NUT	1
060	710-2036	SAW ARM SAFETY SPRING	1	127	745-0112	3/16" ID X 1/2" OD RIVET BURR	2
061	715-0014	1/2" ID X 3/4" OD X 18 GAUGE WASHER	8	128	745-0150	5/16" FLAT WASHER	2
062	715-0024	RUBBER BLOWER BELLOWS	1	129	745-0158	5/16" ID X 1/2" OD X 3/16" NYLON SPACER	3
063	715-0075	ALUMINUM WEDGE PIVOT	1	130	745-0177	1/4 FLAT WASHER	14
064	715-0077	ROUND PIVOT, REAR CAM-OVER HANDLE	1	131	745-0205	DECAL, MADE IN USA (OCTAGON)	1
065	715-0078	1/4-20 NYLON INSERT LOCK HEX NUT	1	132	745-0223	1/4-20 FLANGED LOCK / WHIZ NUT	27
066	715-0091	DECAL, SCROLLER'S HOTLINE	1	135	750-0207	1/4 SPLIT LOCK WASHER	10
067	715-0092	DECAL, RBI HAWK	1	136	750-0213	1/4-20 X 2 CARRIAGE BOLT	1
068	715-0099	BLADE HOLDER C-CLIP, ULTRA SAWS	1	137	770-0050	3/8 FLAT WASHER	1
069	715-0103	1/4" ID X 3/4" OD X 1/16" NYLON SPACER	3	138	770-0058	3/8-16 HEX NUT	9
070	715-0104	HOLD-DOWN FOOT, ULTRA, SCROLL SAWS	1	139	770-0071	3/8 SPLIT LOCK WASHER	1
071	715-0107	WIRE TIE, 6-3/4" TO 7-3/4" LONG	1	140	770-0080	5/16 SPLIT LOCK WASHER	2
073	715-0163	10-32 ACORN CAP NUT	2	141	770-0088	8-32 X 1/2 ROUND HEAD MACHINE SCREW	1
074	715-0164	CAP, BLACK RUBBER, 3" LONG	1	142	770-0095	1/4-20 X 1/4 SKT. SET SCREW, KNURLED CLIP PT.	1
075	715-0191	3/16 INTERNAL LOCK WASHER	1	143	770-0178	5/16-18 X 1 HEX HEAD BOLT	1
076	715-0201	5/64 X 3/8 ROLL/TENSION PIN (220/226)	1	144	780-0019	10-32 X 1 ROUND HEAD MACHINE SCREW	1
077	715-0205	3/16 X 1/2 ROLL/TENSION PIN	1	145	780-0019	10-32 X 1 ROUND HEAD MACHINE SCREW	1
078	715-0210	1/2-13 NYLON INSERTED LOCKNUT	4	146	785-2012	HOLD-DOWN FOOT ROD, 6 INCH	1
079	715-0216	ROUND PIVOT, BOTTOM ARM (REAR)	1	147	790-0031	10-32 X 3/16 SKT. SET SCREW, KNURLED CUP PT.	1
080	715-0236	TABLE TILT SCALE, ALUMINUM	1	148	790-0059	1/4-20 X 1-1/4 SOCKET HEAD CAP SCREW	4
082	715-0244	1/4-20 X 3/4 FLAT HEAD SOCKET CAP SCREW	2	149	791-0053	1/4-20 X 1/4 SOCKET SET SCREW, FLAT POINT	1
				150	795-0063	5/16-18 X 3/4 HEX HEAD BOLT	2
				965-2900		SAW LEG ASSEMBLY	1
				615-1182		ULTRA UPPER BLADE HOLDER ASSEMBLY	1
				615-1231		ULTRA LOWER BLADE HOLDER ASSEMBLY	1
				615-1251		BOLT BAG ASSEMBLY FOR ULTRA SAWS	1

PARTS BREAKDOWN
226 ULTRA HAWK

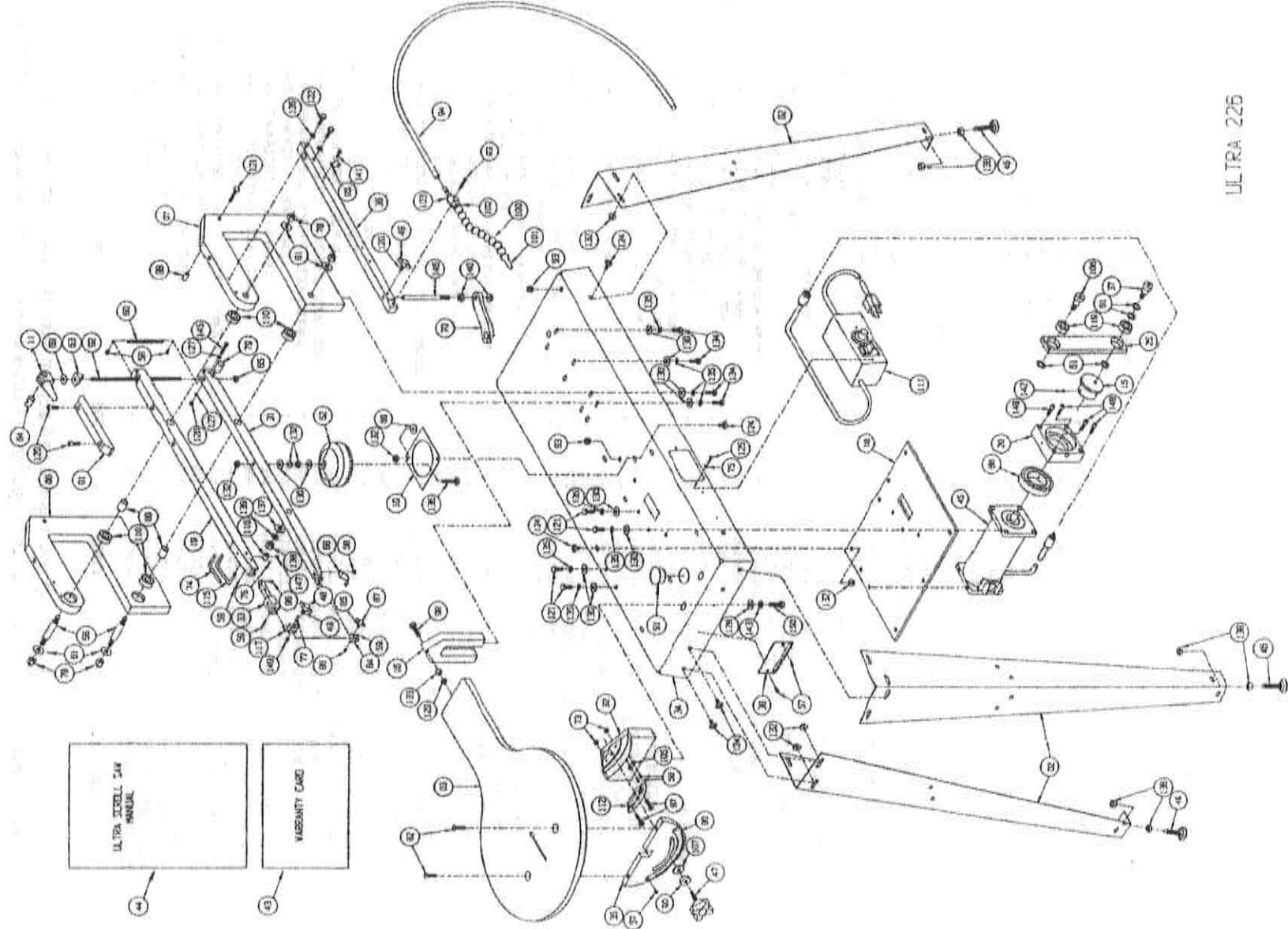

44 ULTRA SCROLL SAW
ANNUAL

43 VARIQUITY CARD

ULTRA 226

PARTS LIST MODEL 226 ULTRA HAWK

To speed up delivery an reduce errors when ordering parts always give the name, model number, and serial number of your machine. Use the part number and description as shown in the parts list. Do not use the key number (the numbers in the circles on the parts breakdown drawing). Always use the part number and description given in the parts list.

Key #	Part #	Description	Qty.	Key#	Part #	Description	Qty.
001	600-0037	TOP ARM REINFORCEMENT, ULTRA 226	1	083	715-0247	8-32 X 1 ROUND HEAD MACHINE SCREW	1
002	600-2007	ULTRA SCROLL SAW LEG	4	084	715-0252	ULTRA LOWER BLADE HOLDER, (ALUMINUM)	1
003	605-5005	LARGE SAW TABLE, ULTRA 220/226	1	085	715-0255	10-32 X 1/2 SOCKET HEAD CAP SCREW	1
006	609-0015	ARM SUPPORT, ULTRA 226, LEFT	1	086	715-0256	10-32 X 3/16 SOCKET SET SCREW, FLAT POINT	1
007	609-0016	ARM SUPPORT, ULTRA 226, RIGHT	1	087	715-0257	PLASTIC THANDLE (#10)	1
010	615-1025	BLOWER BELLOW'S BRACKET	1	088	715-0262	CARRIER BEARING, ULTRA SAWS	1
011	615-1074	REAR CAM-OVER HANDLE, ALUMINUM	1	089	715-0264	POWDERED METAL BRG: 1/2" ID X 5/8" OD X .730"	2
015	615-1263	COUNTERWEIGHT, ULTRA SAWS	1	090	715-0268	DUST SPACER, TABLE TILT, ULTRA SAWS	1
016	615-1270	REAR TABLE SUPPORT, ULTRA 226	1	091	715-0271	KNUST PORT PLUG, ULTRA SAWS	1
018	615-2222	MOTOR BRACE, ULTRA SAWS	1	092	715-0272	TENSION ROD, 9-3/8" LONG	1
019	615-2237	TOP ARM (LONG), ULTRA 226	1	093	715-0273	RUBBER OROMMET, 3/8" ID	2
020	615-2261	CARRIER BEARING CRADLE, ULTRA SAWS	1	094	715-0274	POLYETHYLENE TUBING, 3/8" OD	55
025	615-4193	PITMAN ARM, ULTRA 220/226	1	095	715-0275	NYLON CABLE CLAMP, ULTRA SAWS	1
031	615-5238	BOTTOM ARM (LONG), ULTRA 226	1	096	715-0287	10-32 X 1/4 SKT. ST. SCR., BRASS W / NYL. INSERT	1
032	615-6022	TALL BASE TILT, ULTRA 220/226	1	097	715-0292	10-32 X 3/4 FLAT HEAD SOCKET CAP SCREW	2
033	615-6153	TOP BLADE HOLDER BRACKET, ULTRA 220/226	1	098	715-0293	5/16-18 X 1-1/2 HEX HEAD BOLT	1
034	615-6225	SAW BASE, ULTRA 226	1	099	715-0298	RUBBER CAP, .207" X 1/2"	1
035	615-7020	TABLE TILT, ULTRA SAWS	1	100	715-0298	LOC-LINE 1/4" SEGMENT (BLACK)	1
036	615-7066	HOLD-DOWN ARM, ULTRA 226	1	101	715-0299	LOC-LINE 1/8" ROUND NOZZLE (BLACK)	1
037	625-0033	1/2 X 1/2 SOCKET HEAD SHOULDER BOLT	1	102	715-0307	LOC-LINE 1/4" NPT CONNECTOR (BLACK)	1
038	700-1034	SERIAL TAG, ULTRA 226	1	103	715-0308	FEMALE PIPE THREAD / HOSE BARB (BLACK)	1
039	702-0002	DECAL, RBI MADE IN USA (ROUND)	1	104	715-0310	DECAL, WARNING: DO NOT EXPOSE TO	1
040	702-0011	DECAL, KEEP FINGERS FROM UNDER ARM	1	105	715-1101	SCROLL SAW POINTER	1
041	702-0025	DECAL, PATENT #4,848,761	1	106	715-1109	1/2 X 1 ROUND HEAD SOCKET SHOULDER BOLT	1
042	702-0034	DECAL, RBI MADE IN USA (ROUND)	1	107	715-1120	5/16" ID X 7/8" OD X 1/8" NYLON SPACER	1
043	703-0700	WARRANTY CARD, GENERAL	1	110	715-1208	THRUST BEARINGS, SHIELDED	4
044	703-5729	MANUAL, ULTRA 216-220-226	1	111	715-1258	VARIABLE SPEED CONTROLLER, 90 VDC, 60 HZ	1
045	704-1013	MOTOR, 1/5 HP, 90 VDC, 60 HZ	1	112	715-1288	BASE/TABLE TILT SLIDE (DELTRIN)	1
046	705-0057	GLIDE	4	113	715-2168	ULTRA FRONT CAM HANDLE (220/226)	1
047	705-1042	5/16-18 X 1-1/4 SQUARE KNOB	1	116	715-3154	ROUND FRONT CAM (220/226)	1
048	707-6030	1/4 TEE KNOB	1	117	715-5181	ULTRA ALUMINUM UPPER BLADE HOLDER	1
049	707-6286	1/4-20 X 1/2 SOCKET HEAD CAP SCREW	2	119	735-0007	1/2" ID BALL BEARING	2
050	709-0096	DECAL, CONSULT TECHNICAL MANUAL	1	120	735-0017	1/4-20 X 3/4 SOCKET HEAD CAP SCREW	2
051	709-0097	DECAL, CAUTION, CUTTING OF FINGERS	1	121	735-0052	1/4-20 X 1 HEX HEAD BOLT	3
052	709-0098	DECAL, WEAR EYE PROTECTION	1	122	735-0080	1/4-20 X 1-1/4 HEX HEAD BOLT	5
053	709-0099	DECAL, LIGHTENING BOLT / SHOCK	1	124	745-0099	1/4-20 X 5/8 CARRIAGE BOLT	2
054	709-0124	BOLT, SAW ARM PIVOT, ULTRA 226	2	125	745-0106	10-32 X 1/2 ROUND HEAD MACHINE SCREW	20
057	710-8012	#7 X 5/16 ROUND HEAD DRIVE SCREW	4	126	745-0107	10-32 HEX NUT	2
058	710-0035	10-32 X 1/4 ROUND HEAD MACHINE SCREW	5	127	745-0112	3/16" ID X 1/2" OD RIVET BURR	1
059	710-0042	1/8 X 3/4 ROLL/TENSION PIN	1	128	745-0150	5/16" ID X 1/2" OD X 3/16" NYLON SPACER	2
060	710-2036	SAW ARM SAFETY SPRING	3	129	745-0158	5/16" ID X 1/2" OD X 3/16" NYLON SPACER	2
061	715-0014	1/2" ID X 3/4" OD X 18 GAUGE WASHER	8	130	745-0177	1/4 FLAT WASHER	14
062	715-0024	RUBBER BLOWER BELLOW'S	1	131	745-0205	DECAL, MADE IN USA (OCTAGON)	1
063	715-0075	ALUMINUM WEDGE PIVOT	1	132	745-0223	1/4-20 FLANGED LOCK / WHIZ NUT	1
064	715-0077	ROUND PIVOT, REAR CAM-OVER HANDLE	1	133	745-0517	5/16" ID X 1/2" OD X 1/4" NYLON SPACER	23
065	715-0078	1/4-20 NYLON INSERT LOCK HEX NUT	1	134	750-0206	1/4-20 X 3/4 HEX HEAD BOLT	1
066	715-0091	DECAL, SCROLLER'S HOTLINE	1	135	750-0207	1/4 SPLIT LOCK WASHER	8
067	715-0092	DECAL, RBI HAWK	1	136	770-0650	3/8 FLAT WASHER	14
068	715-0099	BLADE HOLDER C-CLIP, ULTRA SAWS	1	137	770-0071	3/8 SPLIT LOCK WASHER	1
069	715-0103	1/4" ID X 3/4" OD X 1/16" NYLON SPACER	3	138	770-0071	3/8 SPLIT LOCK WASHER	1
070	715-0104	HOLD-DOWN FOOT, ULTRA SCROLL SAWS	1	139	770-0080	5/16-18 FLANGED LOCK / WHIZ NUT	2
071	715-0107	WIRE TIE, 6-3/4" TO 7-3/4" LONG	1	140	770-0088	8-32 X 1/2 ROUND HEAD MACHINE SCREW	1
073	715-0163	10-32 ACORN NUT	1	141	770-0178	5/16 SPLIT LOCK WASHER	1
074	715-0164	CAP, BLACK RUBBER, 3" LONG	2	142	780-0019	10-32 X 1 ROUND HEAD MACHINE SCREW	1
075	715-0191	3/16 INTERNAL LOCK WASHER	1	143	785-2012	HOLD-DOWN FOOT ROD, 6 INCH	1
076	715-0201	5/64 X 3/8 ROLL/TENSION PIN (220/226)	2	144	790-0031	10-32 X 3/16 SKT. SET SCREW, KNURLED CUP PT.	1
077	715-0205	3/16 X 1/2 ROLL/TENSION PIN	1	145	790-0059	1/4-20 X 1-1/4 SOCKET HEAD CAP SCREW	1
078	715-0210	1/2-13 NYLON INSERTED LOCK NUT	1	146	791-0053	1/4-20 X 1/4 SOCKET SET SCREW, FLAT POINT	4
079	715-0216	ROUND PIVOT, BOTTOM ARM(REAR)	4	147	795-0063	5/16-18 X 3/4 HEX HEAD BOLT	1
080	715-0236	TABLE TILT SCALE, ALUMINUM	1	148	795-0063	5/16-18 X 3/4 HEX HEAD BOLT	1
082	715-0244	1/4-20 X 3/4 FLAT HEAD SOCKET CAP SCREW	2	149	795-0063	5/16-18 X 3/4 HEX HEAD BOLT	2
				150	965-2900	SAW LEG ASSEMBLY, ULTRA SAWS	1
					615-1231	ULTRA LOWER BLADE HOLDER ASSEMBLY	1
					615-1182	ULTRA UPPER BLADE HOLDER ASSEMBLY	1
					615-1251	BOLT BAG FOR ULTRA SAWS	1

TABLE TILT ADJUSTMENT PROCEDURES

Your new RBI Ultra Hawk table tilt has been designed and constructed to provide years of trouble free service. It features a delrin polymer insert which guides the movement of the precision machined aluminum tilt assembly. This adjustable insert requires no lubrication, insures a smooth steady operation at any degree of tilt, and provides a positive tilt lock at any angle. Other features include the ability to adjust for wear, an adjustable scale pointer, and the assembly is retrofitable to previously manufactured Hawks.

To Adjust The Tilt Insert: (See Illustration Below)

1. Loosen the two acorn nuts (item #73) on the back side of the base tilt (item #32).
2. Use a 1/8" hex wrench (allen wrench) to slightly tighten or loosen the flathead screws (item #97).
Note: tightening the screws will spread the tilt insert (item #112) and remove any play or wear in the tilt assembly. Likewise, loosening the screws will allow for more freedom of movement in the slide.
3. When the desired tilt movement is achieved, hold the flathead screws (item #97) in the position while re-tightening the acorn nuts (item #73). The acorn nuts will prevent the flat head screws from moving during sawing.

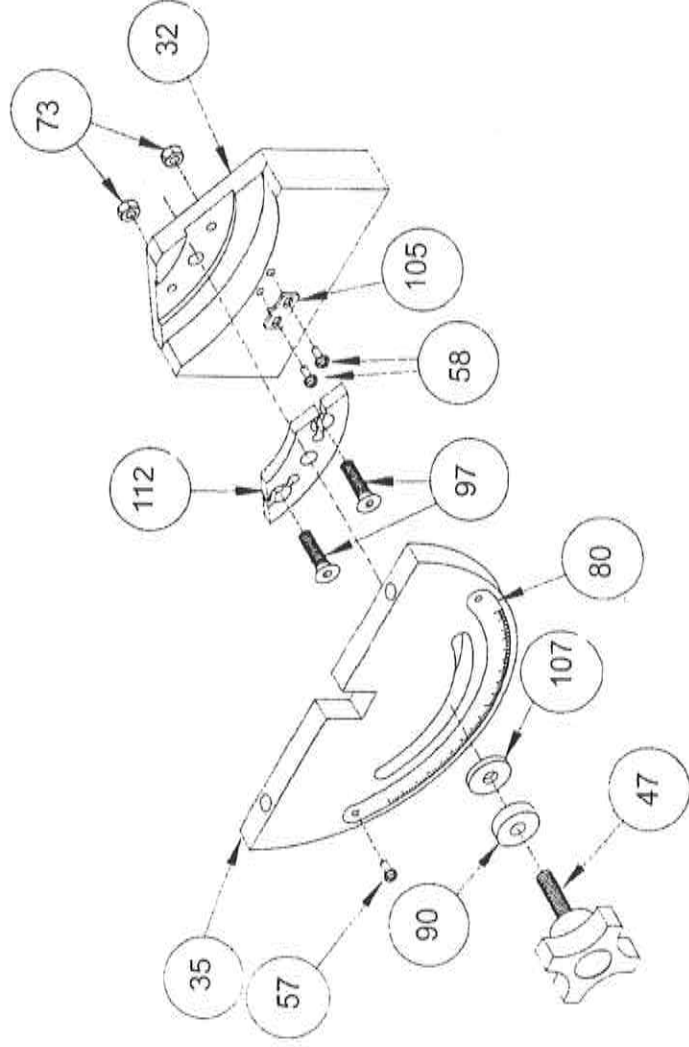

Front Cam-Over Handle And Its Blade Holder Bracket Set Screw Adjustment

RBI has manufactured and installed, in the Hawk Ultra 220 & 226 saws, a set screw adjustment mechanism which allows the saw operator the ability to readjust the front cam-over tension handle. Item #96 (see diagram at right) is a 10-32 x 1/4 Brass set screw with a 3/32 hex wrench opening. Over the course of the lifetime of the saw, one could experience a lifting of the front cam handle, ie: the front-cam handle will not hold in the locked down position. If the cam is wearing the set screw, the handle will try to move into the forward, or released position, by itself.

The remedy is to use a 3/32 hex wrench and turn the brass set screw 1/4 to 1/2 turn in a clockwise or tightening direction. By doing this, it applies pressure on the cam thereby holding it in the locked position. Be careful to not exceed these recommendations, as putting excessive tension on the cam will make cam release a problem and premature wear on the cam and blade holder bracket will occur.

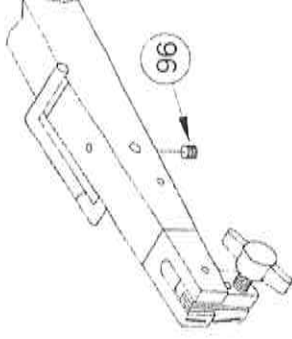

PARTS LIST FOR WHEEL CHAIR ACCESSIBLE PACKAGE

Key #	Part #	Description	Qty.	Key #	Part #	Description	Qty.
01	600-1027	MULTI-POSITION 10 GA. LEG EXT.	4	09	715-0286	1/4-28 ACORN NUT	2
02	615-0277	SAW BASE / LEG EXTENSION - LEFT	1	10	745-0099	1/4-20 X 5/8 CARRIAGE BOLT	26
03	615-0278	SAW BASE / LEG EXTENSION - RIGHT	1	11	745-0223	1/4-20 FLANGED LOCK / WHIZ NUT	26
04	633-2011	MULTI-POSITION SHORT SAW LEGS	4	12	770-0058	3/8-16 HEX NUT	8
05	715-0281	SPHERICAL ROD ENDS	4	13	705-0057	GLIDE, BLACK RUBBER	4
06	715-0282	1/4-28 HEX NUTS	2				
07	715-0283	1/4-28 JAM NUT	2				
08	715-0284	W/C STABILIZER ROD, ULTRA 220	2				
	715-0285	W/C STABILIZER ROD, ULTRA 226	2				

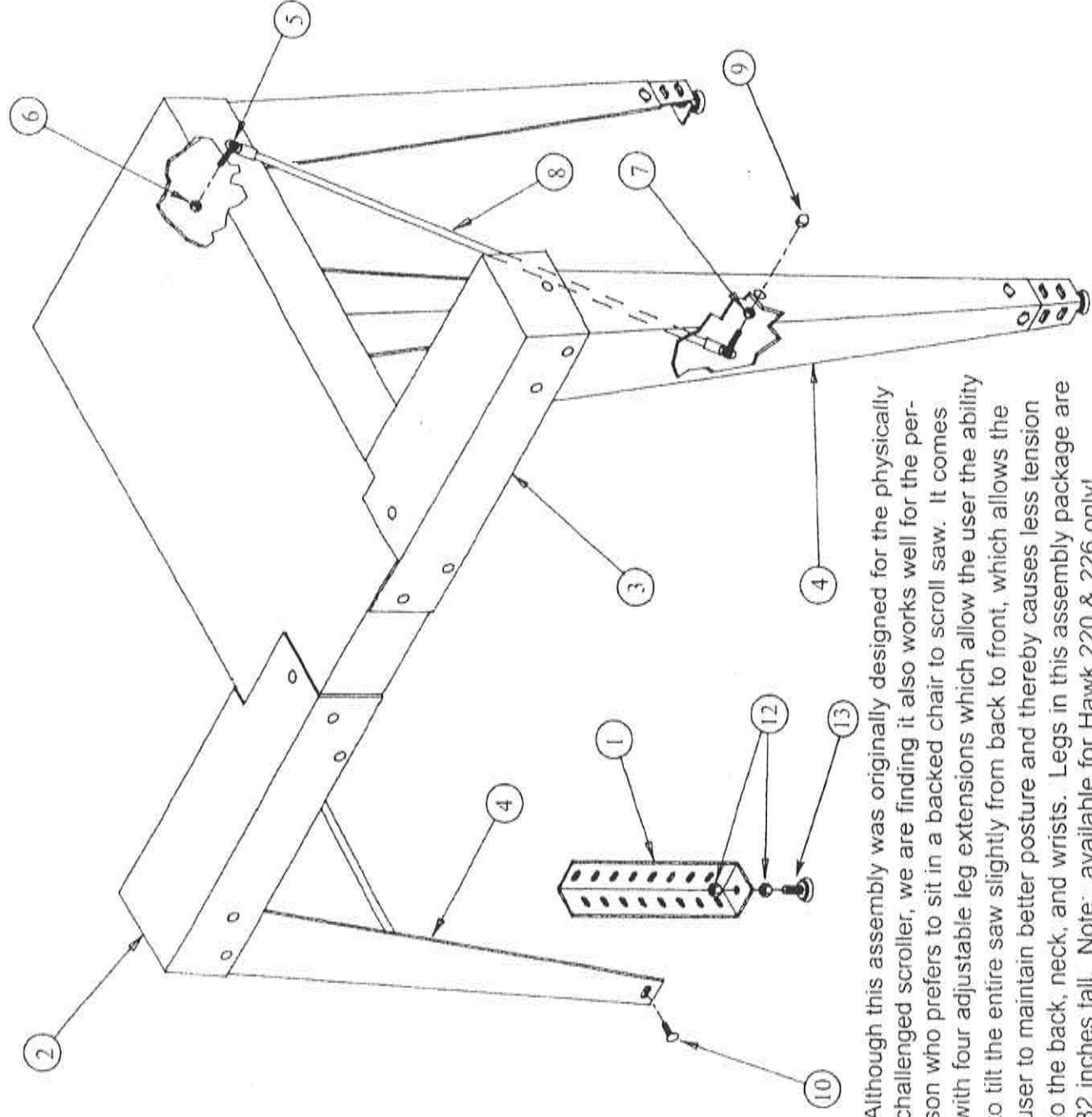

Although this assembly was originally designed for the physically challenged scroller, we are finding it also works well for the person who prefers to sit in a backed chair to scroll saw. It comes with four adjustable leg extensions which allow the user the ability to tilt the entire saw slightly from back to front, which allows the user to maintain better posture and thereby causes less tension to the back, neck, and wrists. Legs in this assembly package are 32 inches tall. Note: available for Hawk 220 & 226 only!

PARTS LIST FOR LEG EXTENSION KIT

Key #	Part #	Description	Qty.
01	600-1027	MULTI POSITION 10 GA. LEG EXT.	2
02	745-0099	1/4-20 X 5/8" CARRIAGE BOLT	4
03	745-0223	1/4-20 FLANGED LOCK/WHIZ NUT	4

The leg extensions can be added to the rear legs of the saw to give a slight tilt to the entire saw so that while one is sitting on a stool, sawing presents less strain to the neck, back, and wrists. In addition, the extensions can be added to all four legs to give the entire saw a lift. This position can be a definite plus for a taller person or a person who prefers to stand while sawing.

Leg extensions are six inches tall with variable adjustment settings.

(Two extensions and hardware per assembly)

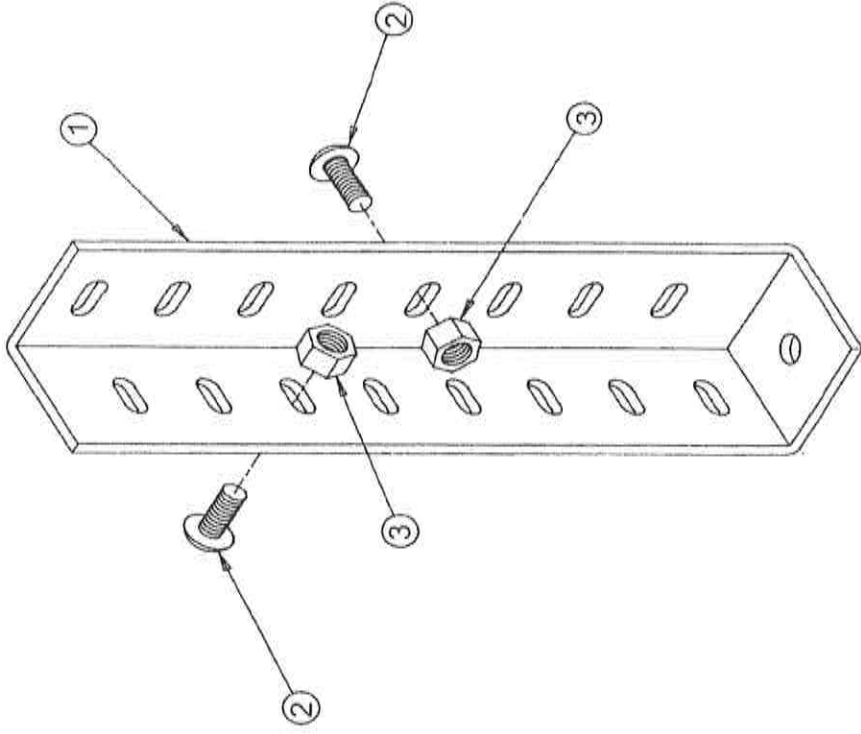

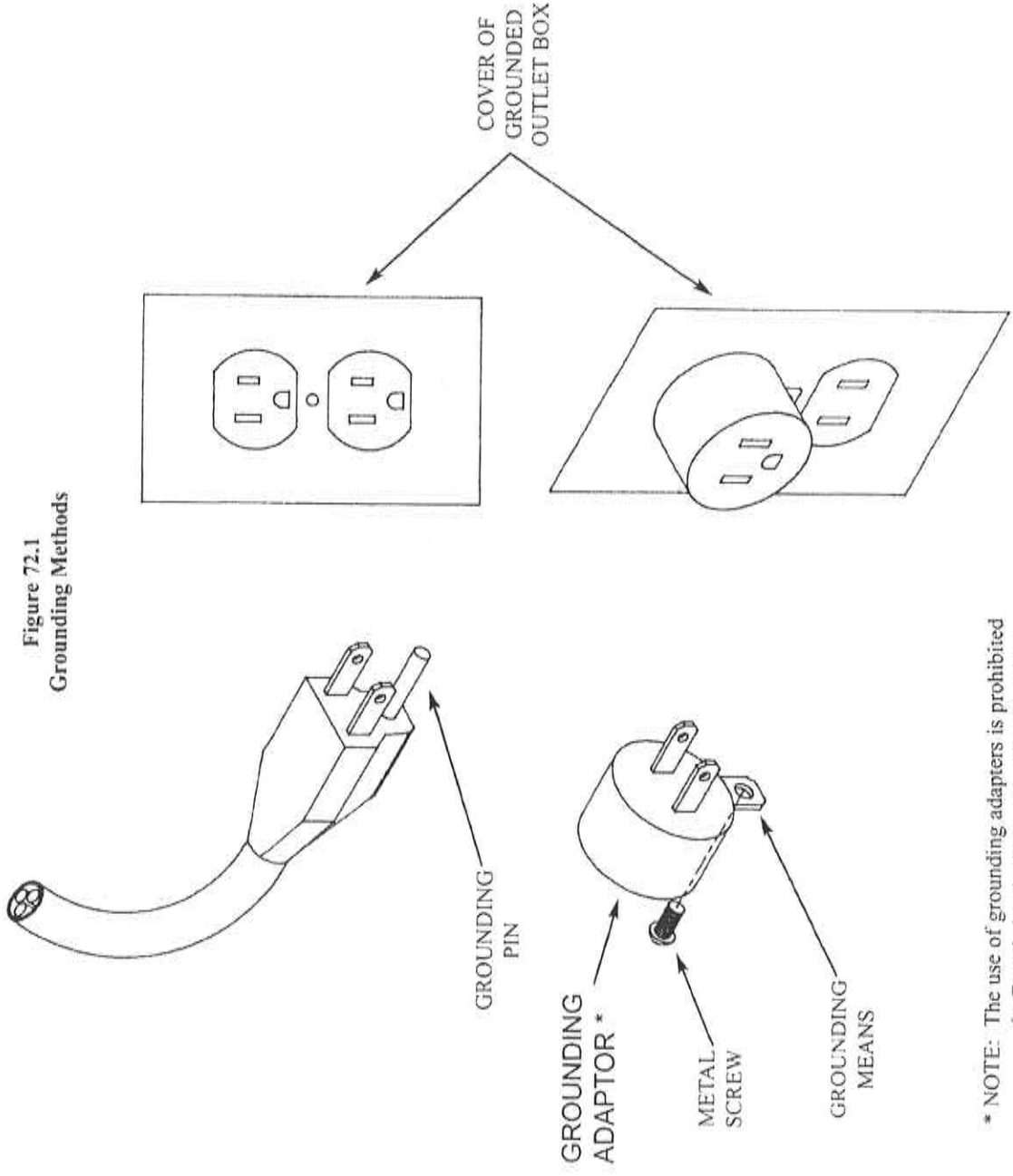

* NOTE: The use of grounding adaptors is prohibited in Canada by the Canadian Electrical Code.

Table 72.1
Minimum Gauge For Cordage

Ampere Rating	Volts			
	120 V	250 ft.	50 ft.	100 ft.
				150 ft.
		50 ft.	100 ft.	300 ft.
	240 V	50 ft.	100 ft.	
Not More Than				
0	18	16	16	14
6	18	16	14	12
10	16	16	14	12
12	14	12	12	NOT RECOMMENDED
			AWG	